





1. Package Contents

Check the following contents of your package:

ST-6HP4	User's Manual
	
Foot Pad	Power Cord
	

If any of these are missing or damaged, please contact your dealer immediately; if possible, retain the carton including the original packing material, and use them again to repack the product in case there is a need to return it to us for repair.

- 1 -

■ Switching

- Hardware-based 10/100Mbps auto-negotiation and auto MDI/MDI-X
- Flow control for full duplex operation and back pressure for half duplex operation
- 1536bytes packet size
- Integrates address look-up engine, supporting 2K absolute MAC addresses
- Automatic address learning and address aging
- Solid DIP switch to isolate ports to prevent broadcast storm and defend DHCP spoofing

■ Hardware

- Desktop palm size
- LED indicators for PoE ready/activity and LINK/ACT
- Supports Contact Discharge of ±4KV DC and Air Discharge of ±6KV DC for Ethernet ESD protection
- Supports ±4KV Surge Immunity
- Internal AC power supply
- Fanless design

- 3 -

Standard PoE Mode

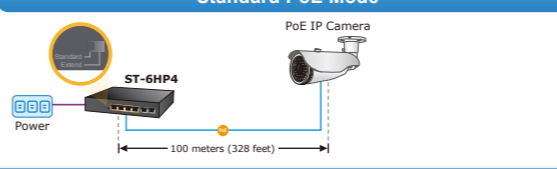

Extend PoE Mode

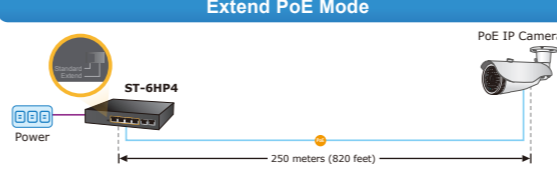

● 100BASE-TX UTP with PoE
● 10BASE-T UTP with PoE

Note After changing the mode, you need to manually restart the ST-6HP4 to make the corresponding configuration take effect.

- 5 -

5. Switch Rear Panel

Figure 5-1 shows the rear panel of the ST-6HP4.



Figure 5-1: ST-6HP4 Rear Panel



Power Notice

1. The device is a power-required device, meaning it will not work till it is powered. If your networks should be active all the time, please consider using UPS (Uninterrupted Power Supply) for your device. It will prevent you from network data loss or network downtime.
2. In some areas, installing a surge suppression device may also help to protect your ST-6HP4 from being damaged by unregulated surge or current to the ST-6HP4.

- 7 -

2. Product Features

■ RJ45 Interface

- 6-port 10/100TX Ethernet RJ45 copper
- 4-port IEEE 802.3af/at PoE Injector (Port-1 to Port-4)

■ Power over Ethernet

- Complies with IEEE 802.3af/at Power over Ethernet end-span PSE
- Up to 4 IEEE 802.3af/2 IEEE 802.3at devices powered
- Supports PoE power up to 30 watts for each PoE port
- 60-watt PoE budget
- Hardware DIP switch for "Standard" and "Extend" mode selection; the "Extend" mode features 30-watt PoE transmit distance of 250m at speed of 10Mbps and VLAN isolation
- Auto detects powered device (PD)
- Circuit protection prevents power interference between ports
- Remote power feeding up to 100m in standard mode

- 2 -

3. Switch Front Panel

Figure 3-1 shows the front panel of the ST-6HP4.



Figure 3-1: ST-6HP4 Front Panel

The front panel of the ST-6HP4 provides one DIP switch for "Standard" and "Extend" mode selections. The detailed descriptions are shown in the following table.

DIP Switch Mode	Function
Standard (default)	This mode makes the ST-6HP4 operate as a general switch and all ports operate at 10/100Mbps auto-negotiation.
Extend	<ul style="list-style-type: none"> ■ This mode makes the ST-6HP4 operate as a VLAN isolation switch and port 1 to port 4 will isolate respectively. Port 1 to port 4 can communicate with port 5~6 (uplink port). ■ This mode also makes the ST-6HP4 operate at auto-negotiation 10Mbps speed duplex mode only, but the delivery distance of PoE power and network data can reach 250m.

- 4 -

System

LED	Color	Function
PWR	Orange	Lights to indicate the Switch has power.

Per 10/100Mbps Port

LED	Color	Function
PoE	Orange	Lights to indicate the port is providing 52V DC in-line power to remote PoE PD.
LNK/ACT	Green	Lights to indicate the link through that port is successfully established at 10/100Mbps. Blinks to indicate that the Switch is actively sending or receiving data over that port.

- 6 -

6. Installing the Switch

This part describes how to install your ST-6HP4 and make connections to it. Please read the following topics and follow the procedures as presented.



Note

This ST-6HP4 does not need software configuration.

Desktop Installation

To install the ST-6HP4 on desktop, simply follow the following steps:

- Step 1:** Place the ST-6HP4 on desktop near an electrical outlet.
- Step 2:** Keep enough ventilation space between the ST-6HP4 and the surrounding objects.



Note

When choosing a location, please keep in mind the environmental restrictions discussed in Chapter 7 -- Product Specifications.

- Step 3:** Connect your ST-6HP4 to network devices.

A. Connect one end of a standard network cable to the **Port-5~6** of the ST-6HP4 that marks with "**Uplink**".

- 8 -

www.beward.ru

PoE Switch
ST-6HP4

**4-Port 10/100TX 802.3af/at PoE +
2-Port 10/100TX Desktop Switch**



BEWARD Co., Ltd

Warning:
This equipment is compliant with Class A of CISPR 32.
In a residential environment this equipment may cause radio interference.



B. Connect the other end of the cable to the network devices such as routers, Ethernet switches or NVRs (network video recorders).

Step 4: Connect your ST-6HP4 to PoE PDs.

A. Connect one end of a standard network cable to one of the four 10/100Mbps RJ45 PoE+ ports of the ST-6HP4.

B. Connect the other end of the cable to the 802.3at/af PD.

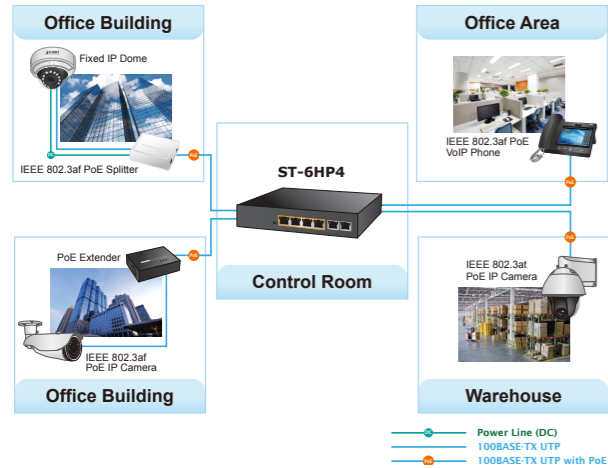

Wall-mount Installation

Step 1: Please find the wall that can mount the ST-6HP4.

Step 2: Please refer to the picture below and screw the two screws on the wall.

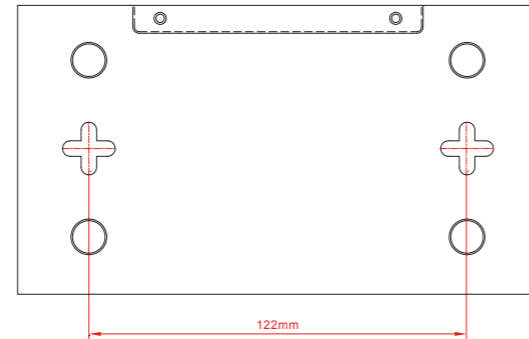

Step 3: Hang the ST-6HP4 on the screws from the wall.

Step 4: Repeat step 5 of **Desktop Installation** for power supply to the ST-6HP4.

Note Before mounting the device to the wall, please check the location of the electrical outlet and the length of the Ethernet cable.

Cable distance for Switch

■ If the "DIP Switch Mode" is set to "Standard", then the distance between the ST-6HP4 and PC/PD should not exceed 100 meters for UTP/STP cable.

■ If the "DIP Switch Mode" is set to "Extend", then the distance between the ST-6HP4 and PC/PD should not exceed 250 meters.

Make sure the wiring is correct

Category 3/4/5 cable can be used in 10 Mbps operation. To reliably operate your network at 100Mbps, you must use an unshielded twisted-pair (UTP) Category 5/5e cable, or better data grade cabling. While a Category 3 or 4 cable may initially seem to work, it will soon cause data loss.

Step 5: Supply power to the ST-6HP4.

A. Connect one end of the power cable to the Switch.

B. Connect the power plug of the power cable to a standard wall outlet.

When the Switch receives power, the power LED should remain solid Orange.

7. Product Specifications

Model	ST-6HP4 4-Port 10/100Mbps 802.3af/at PoE + 2-Port 10/100Mbps Desktop Switch
Hardware Specifications	
Network Connector	6-Port RJ45 for 10/100BASE-TX, auto MDI/MDIX
PoE Inject Port	4-Port with 802.3af/at PoE injector function (Port 1 to port 4)
LED Display	System: Power (Orange) Per PoE port: PoE (Orange, port 1 to port 4) LNK/ACT (Green, port 1 to port 6)
DIP Switch	Distance in Standard mode is 100M Distance in Extend Mode is 250M Base on the cable category
Switch Architecture	Store and Forward switch architecture
MAC Address Table	2K MAC address table with auto learning function
ESD Protection	6KV
Switch Fabric	1.2Gbps
Switch Throughput	0.89Mpps @64bytes
Maximum Packet Size	1536bytes
Flow Control	Back pressure for half duplex. IEEE 802.3x pause frame for full duplex
Power Requirements	AC 100~240V, 2A max.
Power Consumption	Max. 63 watts, 214 BTU
Dimensions (W x D x H)	168 x 93 x 32mm
Weight	499g

Power over Ethernet	
PoE Standard	IEEE 802.3af Power over Ethernet/PSE IEEE 802.3at Power over Ethernet Plus/PSE
PoE Power Supply Type	End-span
Power Pin Assignment	1/2 (+), 3/6(-)
PoE Power Output	Per Port 52V DC, 300mA. max. 15.4 watts (IEEE 802.3af) Per Port 52V DC, 600mA. max. 30 watts (IEEE 802.3at)
PoE Power Budget	60 watts
Number of PDs (7 watts)	4
Number of PDs (15.4 watts)	4
Number of PDs (30 watts)	2
Standard Conformance	
EMI Safety	CE, FCC
Standard Compliance	IEEE 802.3 Ethernet IEEE 802.3u Fast Ethernet IEEE 802.3x Flow Control IEEE 802.3af Power over Ethernet IEEE 802.3at Power over Ethernet Plus
Environment	
Operating Environment	0 ~ 50 degrees C
Storage Environment	-10 ~ 70 degrees C
Operating Humidity	5 ~ 95%, relative humidity, non-condensing
Storage Humidity	5 ~ 95%, relative humidity, non-condensing

8. Customer Support

Thank you for purchasing BEWARD products. You can browse our online FAQ resource on BEWARD Website first to check if it could solve your issue. If you need more support information, please contact BEWARD switch support team.

BEWARD website:
www.beward.ru

Copyright © BEWARD Co., Ltd
Contents are subject to revision without prior notice.
BEWARD is a registered trademark of BEWARD Co., Ltd. All other trademarks belong to their respective owners.