

Installation User Manual

www.beward.eu

IP CAMERA N100

MicroSD/SDHC card slot
Built-in multi-zone motion detection
16 channel surveillance software included



Table of Contents

CHAPTER 1. SAFETY INSTRUCTIONS	2
CHAPTER 2. OVERVIEW	4
2.1. FEATURES	5
2.2. SPECIFICATIONS	5
2.3. PACKAGE CONTENTS	6
CHAPTER 3. PRODUCT DESCRIPTION	7
3.1. FRONT SIDE	7
3.2. REAR SIDE	8
CHAPTER 4. INSTALLING THE CAMERA AND CABLES' CONNECTING	9
4.1. GENERAL INFORMATION	9
4.2. INSTALLATION RECOMMENDATIONS	9
4.3. INSTALLING THE CAMERA	10
4.4. WIRED CONNECTION TO A NETWORK	11
CHAPTER 5. SETTING UP THE WIRED CONNECTION FOR WINDOWS 7	12
5.1. DEFINING THE LOCAL NETWORK PARAMETERS FOR WIRED CONNECTION	12
5.1.1. <i>Defining the Local Network Parameters when using a Dynamic IP Address</i>	16
5.2. CHANGING THE LOCAL NETWORK PARAMETERS	19
5.3. ACCESSING THE IP CAMERA	23
5.3.1. <i>Installing "BEWARD IP Installer" Software</i>	23
5.3.2. <i>Accessing the IP Camera Using "BEWARD IP Installer" Software</i>	23
5.3.3. <i>Accessing the IP Camera Using the Network Menu in Windows 7</i>	25
5.3.4. <i>Accessing the IP Camera Using Internet Explorer</i>	26
5.4. ACCESSING THE CAMERA'S WEB INTERFACE	26
5.5. CONFIGURING THE CAMERA'S NETWORK SETTINGS THROUGH THE WEB INTERFACE	29
5.6. RESTORING THE NETWORK SETTINGS OF THE COMPUTER TO THEIR PREVIOUS VALUES	30
5.7. VERIFYING THE CONNECTION SETTINGS	34
CHAPTER 6. ACCESSING THE CAMERA OVER INTERNET	36
6.1. OVERVIEW OF INTERNET ACCESS TO THE CAMERA	36
6.2. USING AN EXTERNAL STATIC IP ADDRESS OR PPPoE CONNECTION	36
6.2.1. <i>Using an External Static IP Address</i>	36
6.2.2. <i>Using a PPPoE Connection</i>	38
6.3. INTERNET ACCESS TO THE CAMERA ON A LOCAL NETWORK	39
6.3.1. <i>Using the UPnP Option</i>	40
6.3.2. <i>Manual Port Forwarding</i>	41
6.4. ACCESSING OVER THE INTERNET USING DYNDNS SERVICE	47
6.4.1. <i>Overview of Internet Access to Cameras Using DynDNS service</i>	47
6.4.2. <i>Creating an Account at DynDNS Service</i>	47
6.4.3. <i>Creating a Domain Name at DynDNS</i>	51
6.4.4. <i>Setting up the Equipment to Work with DynDNS</i>	55
APPENDIX	59
APPENDIX A. PORT VALUES	59
APPENDIX B. FACTORY DEFAULTS	60
APPENDIX C. GLOSSARY	61

Chapter 1. Safety Instructions

Before using this product

This camera complies with all safety rules. However, improper use of any electric device can be a cause of fire and bring to property damage. Before you start using this camera, please study this user manual carefully.

IMPORTANT!

Use accessories recommended by the manufacturer only. Use of the improper accessories may cause camera's breakdown.

Follow the operating instructions

- Do not use and store this camera in severe environment:
- avoid extremely low or high ambient temperatures (the camera's operating temperature is 0°C to +40°C)
- avoid exposure to direct sunlight and do not locate the camera near any heat sources
- avoid exposure to high humidity
- do not locate the camera near any electrical appliances which can be electromagnetic transmitters
- avoid exposure to high vibration

IMPORTANT!

In case of malfunction of the product contact our Service Center.

In case of:

- detection of a strange smell or smoke
- penetration of any liquid or foreign objects into the camera
- the camera has been dropped or damaged

Do the following:

- unplug the power cord and disconnect all other cords from the camera
- contact our Service Center. You can find contact information on our website: <http://www.beward.eu/>.

Transportation

Transport the camera carefully, using the original box and protective packing.

Ventilation

To prevent overheating of the device, keep free air circulation in the area where the camera is located.

Cleaning

Use a soft, dry cloth for cleaning camera's external surfaces. It is acceptable to use some detergent for removing persistent dirt, but not the volatile cleaners such as the alcohol-containing solvents, benzene and so on, because of the risk to damage the camera's housing.

Chapter 2. Overview

BEWARD N100 is a compact VGA IP-camera (*Pic. 2.1*) with H.264/MPEG-4/MJPEG multi-stream video, a built-in microphone, the microSD/SDHC card slot and a new generation highly sensitive CMOS image sensor.



Pic. 2.1

BEWARD N100 makes possible watching real-time video recording from any part of the world by means of the most standard operating systems and web browsers.

One of the most important camera's features is the function which allows you to create and customize different video profiles for more flexible and comfortable operation. Specifying characteristics such as a compression type, a resolution, a maximum frame rate and a bit rate for each profile, you get optimal image quality according to current channel bandwidth.

There are H.264, MPEG-4, MJPEG compression types the camera supports and simultaneous multi-streaming can be provided.

H.264 (also known as MPEG-4 Part 10) offers higher video resolution than Motion JPEG or MPEG-4 at the same bit rate, or the same video quality at a lower bit rate.

Motion JPEG provides a high quality video stream but it requires relatively big channel capacity and enough free space for recording.

The camera connects to a network using a 10/100BASE-TX Ethernet wire interface. A 1 m length patch cord for camera's initial setting is included.

A high quality of the image is provided by a progressive scan highly sensitive CMOS image sensor and very efficient methods of video encoding also.

The microSD/SDHC memory cards support improves camera's capabilities and makes its operation safer. In case of disconnection all important information will be saved to the card.

2.1. Features

- Optimal quality-price ratio
- Progressive scan CMOS image sensor
- microSD/SDHC memory cards support
- Professional 16-channel software included
- Simultaneous multi-streaming H.264/MPEG-4/M-JPEG for optimal playback and recording of video data
- Viewing recorded files via the web interface with a built-in player
- Built-in microphone
- Built-in motion and audio detector
- Sending of images or video data by e-mail and transmission by FTP
- Recording of images and video data to a shared folder (Windows or Linux OS) or to NAS (Network Attached Storage)
- ONVIF support

2.2. Specifications

- 1/4" progressive scan VGA CMOS image sensor
- Lens (optionally): f3.6 mm F2.0 (angle of view 58° horizontally)
- Resolution: 640x480, 320x240, 160x120
- Sensitivity: 0.2 lux @ F2.0
- Frame rate: up to 30 fps at all resolutions
- Video encoding: H.264, MPEG-4, MJPEG
- Simultaneous multi-streaming: H.264, MPEG-4, MJPEG formats
- One-way audio streaming; compression: G711 μ -law, α -law, AMR
- Protocols supported: Bonjour, TCP/IP, DHCP, PPPoE, ARP, ICMP, FTP, SMTP, DDNS, NTP, UPnP, RTSP, RTP, RTCP, HTTP, TCP, UDP, 3GPP/ISMA RTSP
- Power: 5V, 0.6 A DC
- Operating temperature: 0 to +40°C
- Operating humidity: 20-80% (without condensation)
- ONVIF support

2.3. Package Contents

- IP camera with a pre-installed lens (M12, f3.6 mm, F2.0)
- Patch cord (1 m length)
- Power supply: 5 V 1A
- A bracket with a mounting kit
- CD with user manuals and software
- Quick Installation Guide

Chapter 3. Product Description

3.1. Front Side



Pic. 3.1

Focus adjustment ring: rotate the metal ring to set a focus (previously the focus is preset and does not need to be adjusted).

Power LED: lights when the camera is switched on.

- **Red steady:** power is being supplied to the camera, the system is loading.
- **Blue steady:** the system loading is complete; the camera is ready to be configured through the web interface.
- **Blinking violet:** the camera's firmware is updating. Do not switch off the camera and do not close a browser's window till the process completing.
- **Unlit:** power is not supplied to the camera or the LED indicator is turned off.

Network LED: lights when the camera is connected to a network.

- **Blinking blue:** the camera is connected to a wired network.
- **Unlit:** the camera is not connected to a wired network or the LED indicator is turned off.

Built-in microphone: allows you to hear what happens in the surveillance area.

3.2. Rear Side

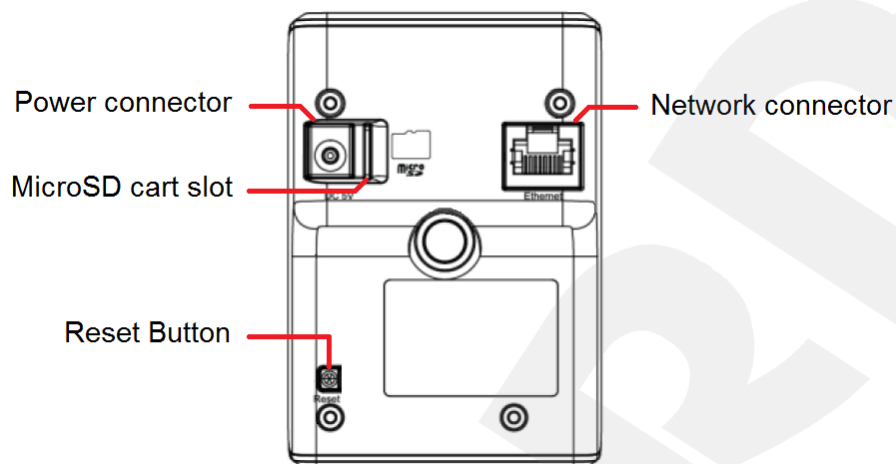

Pic. 3.2

Power connector: for 5 V, 1 A DC power supply.

It is recommended to use the original power supply only for correct camera's operation.

Network connector: is used for connection to LAN or to the Internet by an RJ-45 connector..

MicroSD card slot: provides recording of information on the microSD/SDHC memory cards. In case of disconnection an option of automatic backup recording is also available.

Reset button: when the camera is switched on, press this button to reboot the camera. Press and hold this button for at least 10 seconds to reset the camera to factory defaults. If you hold this button during less than 10 seconds, the camera will reboot without reset to the factory defaults.

Moreover, there are a screw hole for attaching a bracket on the rear side and a label which contains the following information:

SN: IP camera serial number.

MAC: IP-camera MAC address (LAN).

Chapter 4. Installing the Camera and Cables' Connecting

4.1. General Information

BEWARD N100 supports wired connection only and can be connected to LAN or to the Internet. The camera can be connected directly to a computer or through a router.

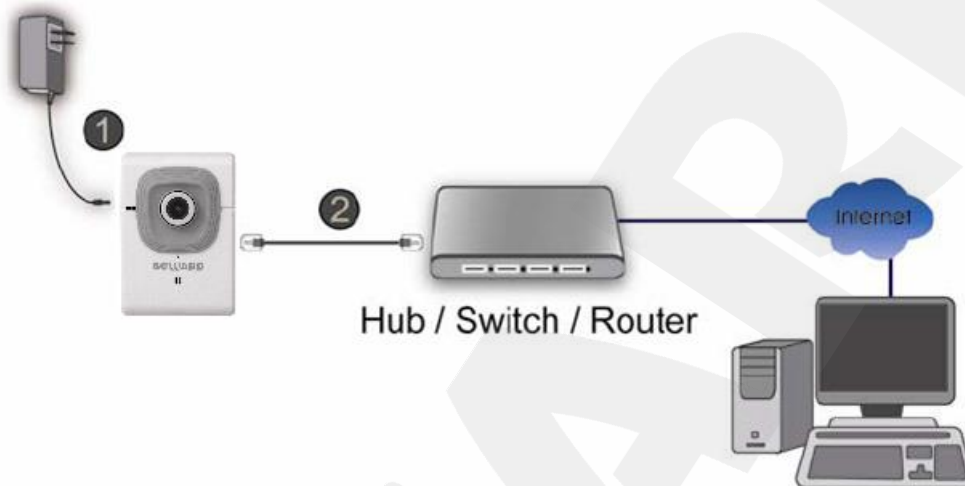

Pic. 4.1

A common home router has one WAN port for Internet access and four LAN ports to connect computers, IP cameras and other devices on your local network.

4.2. Installation Recommendations

This section contains recommendations that should be considered when mounting and installing the N100.

Recommendations on camera placement:

- This camera is designed for indoor video surveillance. The operating temperature range is 0°C to +40°C.
- Avoid exposure to direct sunlight and do not locate the camera near any heat sources.
- Incorrect installation may cause undesirable “blind spots”, zones that are not visible to the camera’s operator.
- Avoid exposure to high humidity.
- Do not locate the camera near any electrical appliances which can be electromagnetic transmitters.
- When installing the camera, be convinced of possibility of free laying connecting cables.
- Avoid unstable installation, which may allow exposure to high vibration. This may reduce motion detection performance and image crispness in whole.

- Cameras in video surveillance system should be installed so that probability of their damage or viewing direction changing or any other unauthorized action was excluded.
- The viewing direction should be clearly determined at the moment of the camera's installation.

Recommendations on twisted pair cable installation:

- In corridors, It is advisable to install electric and feeble-current cables in different conduits that are disposed on different walls.
- Twisted pair and electric cables can be installed in the same conduit using different sections of the cable that have solid longitudinal partitions with at least 0.25 h of fire resistance, which are made of non-combustible material and should be positioned in work areas at distance of 15 meters maximum if the electrical power does not exceed 5 kW.
- Electric and feeble-current cables should be placed in parallel to each other at distance of at least 50 mm in different conduits or different sections of conduit. If the electric field strength from the electric cables exceeds 3 V/m, you should increase the distance between the electric and feeble-current cables or reduce the electromagnetic noise.
- Twisted pair and electric cables should cross each other at right angles.
- Unshielded twisted pair cables should be located at distance of at least 125 mm from fluorescent gas-discharge lamps or from other high-voltage discharge devices.
- Unshielded twisted pair cables should be located at distance of at least 1.5 meters from electromagnetic interference sources that produce electric field strength exceeding 3 V/m.
- Switchboards with pinned unshielded twisted pair cables should be located at distance of at least 3 meters from electromagnetic interference sources that produce electric field strength exceeding 3 V/m.
- Entire twisted pair cables should be arranged between the points of connection so the cable run is as short as possible.
- Minimum cable bending radius is four times the cable diameter (or 1 inch=2.5 cm) or it is also acceptable to install the cable so that the cable bending radius is 2 inches (5 cm).
- Maximum length of the entire segment is 100 meters.

4.3. Installing the Camera

Step 1: attach the bracket to the surface using 3 self-tapping screws.

Step 2: loosen the bracket screws to move the camera to the desired position.

Step 3: attach the camera to the bracket, adjust the tilt angle and fasten the camera (Pic. 4.2).

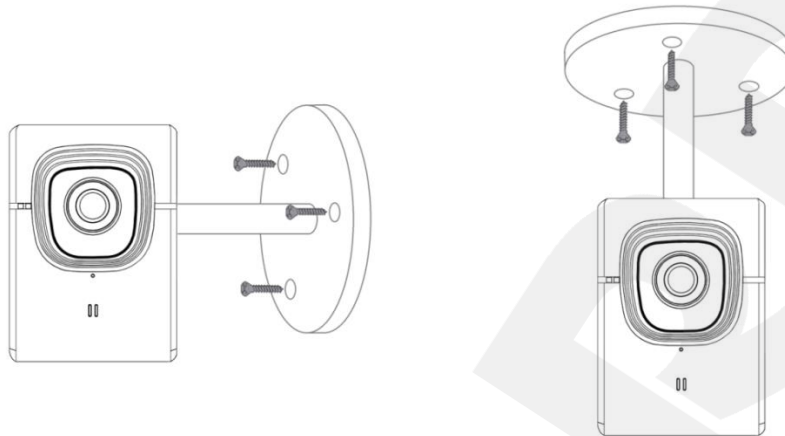

Pic. 4.2

4.4. Wired Connection to a Network

Step 1: provide the camera with power using the included 5 V, 1 A power supply.

Step 2: use the included RJ-45 cable to connect the camera to a network (a LAN port of a router).

You can purchase a network cable separately or if you have the materials, tools and skills, you can make a network cable by yourself.

A straight RJ-45 cable (UTP category 5e)

The table below shows an example of a patch cord to connect the camera to a computer or a network switch.

One end		Other end	
	1: White and orange		1: White and orange
	2: Orange		2: Orange
	3: White and green		3: White and green
	4: Blue		4: Blue
	5: White and blue		5: White and blue
	6: Green		6: Green
	7: White and brown		7: White and brown
	8: Brown		8: Brown

To make a network cable, you need the following materials: a UTP category 5e cable, two RJ-45 connectors and an RJ-45 crimping tool.

Assembling the pairs of wires in the correct order (see the table above) ensures data transfer speed of 100 Mbps.

Chapter 5. Setting up the Wired Connection for Windows 7

To make the N100 IP camera work together with computers, laptops and other devices in your local network, you need to connect this camera to the network according to the network parameters. This chapter explains how to define the network parameters.

NOTE:

The connection establishment process is shown for OS Windows 7 Ultimate. Despite titles of system menus and options may differ from the titles of system menus and options that appear in other versions of Windows, the procedure of the connection establishment process is universal.

5.1. Defining the Local Network Parameters for Wired Connection

When connecting the camera using an Ethernet cable, you need to define local network parameters.

To do so, go to **Start – Control Panel** (Pic. 5.1).

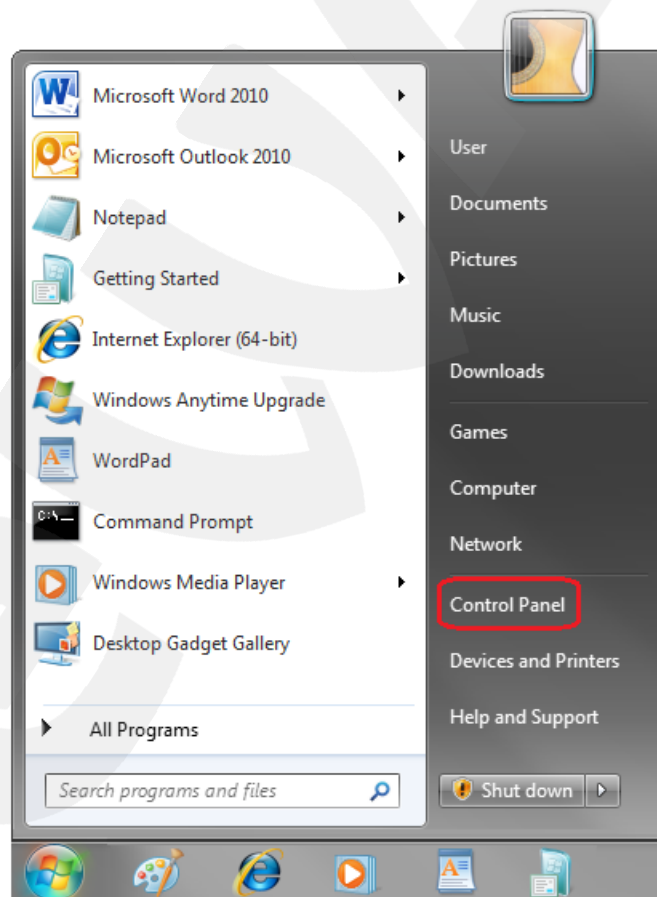

Pic. 5.1

In the opened window click on the **[View network status and tasks]** in the **[Network and Internet]** section (Pic. 5.2).

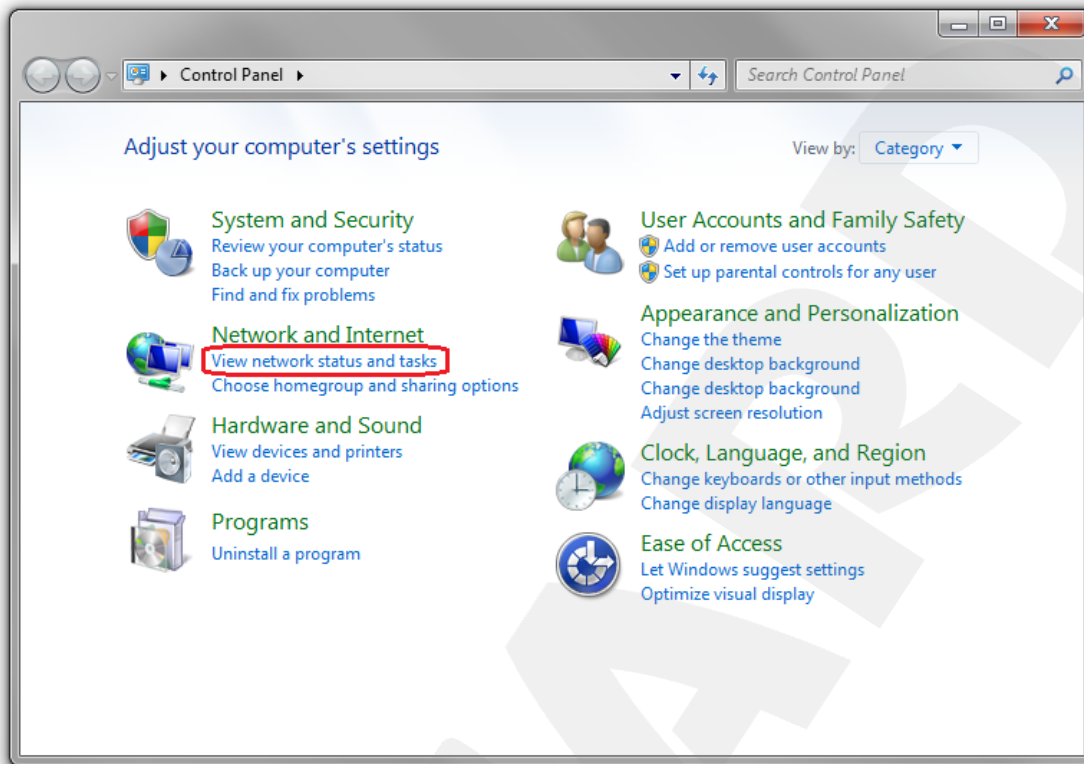

Pic. 5.2

In the opened window click on the **[Local Area Connection]** (Pic. 5.3).

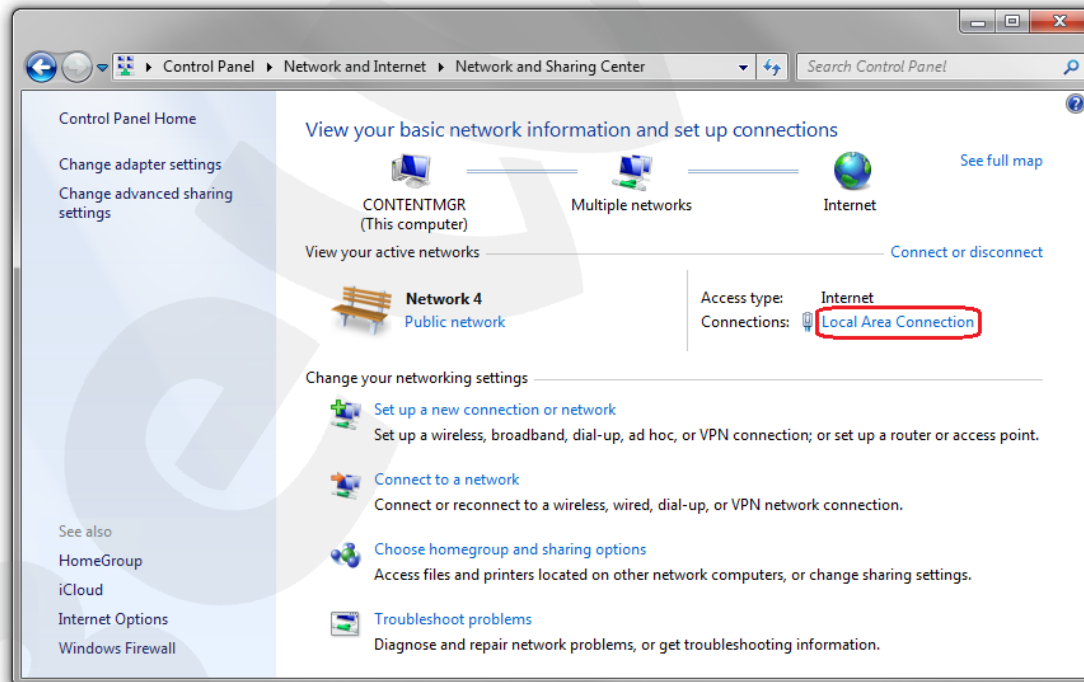

Pic. 5.3

NOTE:

If there are several active networks, choose the one that you are going to connect your camera to.

In the opened window click the **[Properties]** button (Pic. 5.4).

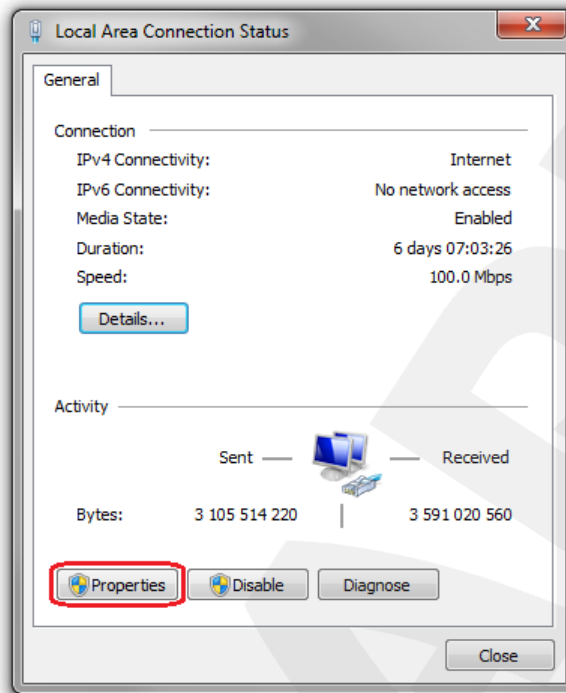

Pic. 5.4

In the opened window select the **[Internet Protocol Version 4 (TCP/IPv4)]** menu item and click the **[Properties]** button (Pic. 5.5).

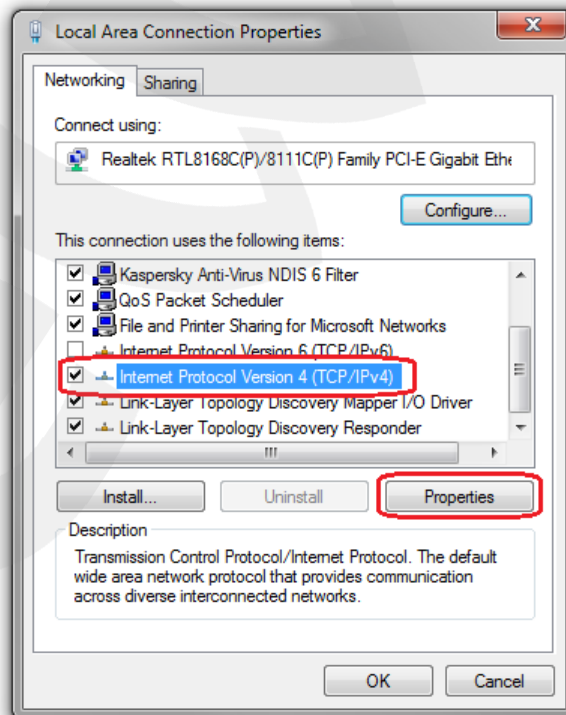

Pic. 5.5

The window opens displaying information about the network connection settings. There are two ways to configure the IP address:

1. **Obtain an IP address automatically:** select this option to obtain an IP address automatically from a DHCP-server on your network (Pic. 5.6). If an IP address is assigned to your computer automatically, go to paragraph [5.1.1](#) to define the network parameters.

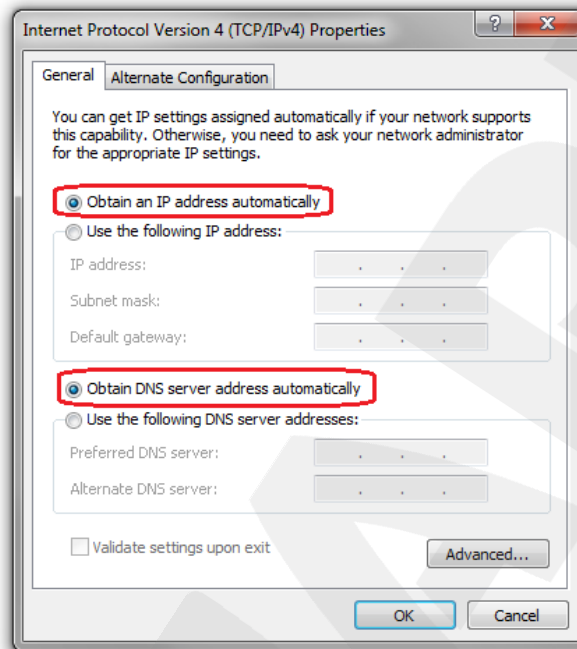

Pic. 5.6

2. **Use the following IP address:** an IP address is specified manually (Pic. 5.7).

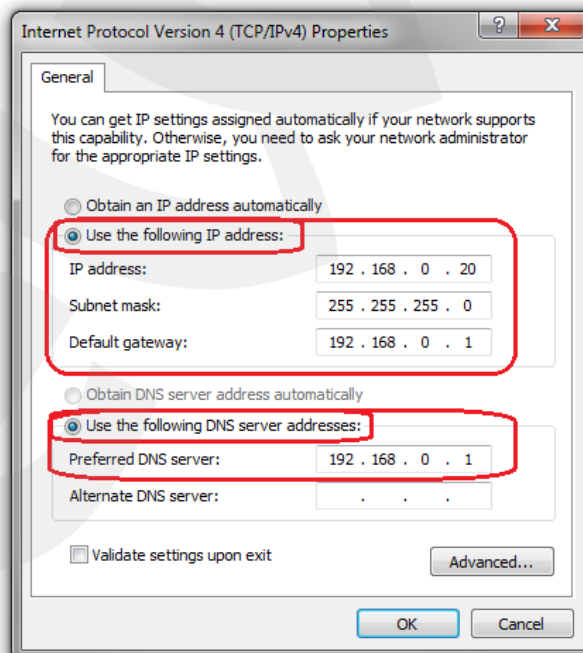

Pic. 5.7

Make a note of the following parameters: IP address, Subnet mask, Default gateway, DNS server.

IMPORTANT!

If you do not make a note of the network parameters, then it will be impossible to return the computer's network settings to their initial state and to connect it to a local network or the Internet after configuring the N100.

5.1.1. Defining the Local Network Parameters when using a Dynamic IP Address**NOTE:**

This paragraph explains how to define the local network parameters if an IP address is assigned to your computer automatically (by DHCP-server).

Connect a computer (laptop) to your local network using a network cable and wait till the connection process completing.

To define the local network settings, go to **Start – Control Panel** (Pic. 5.8).

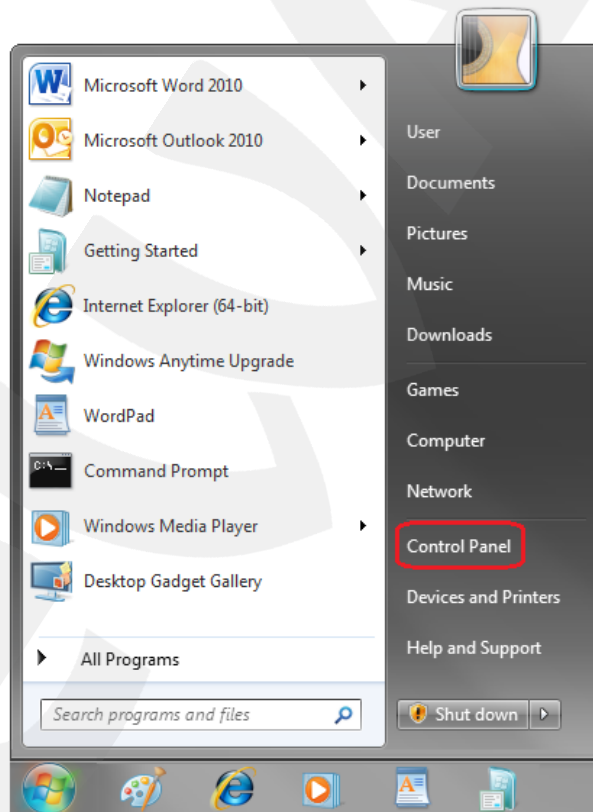

Pic. 5.8

In the opened window click on the **[View network status and tasks]** in the **[Network and Internet]** section (Pic. 5.9).

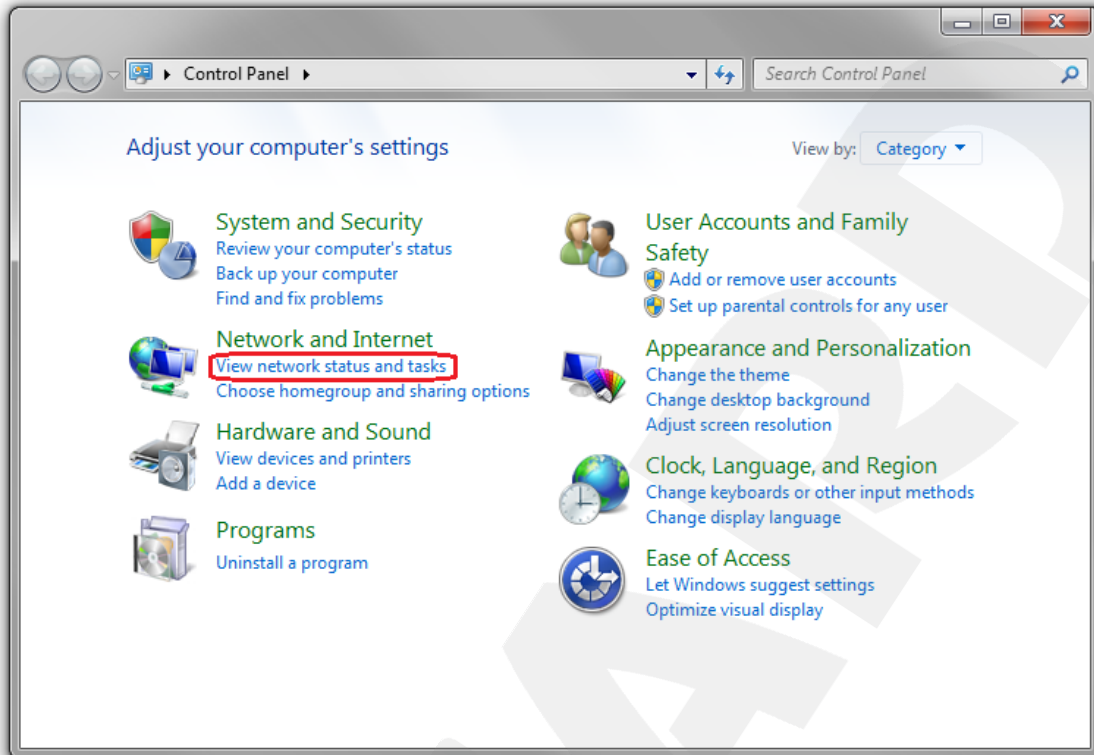

Pic. 5.9

In the opened window click on the **[Local Area Connection]** (Pic. 5.10).

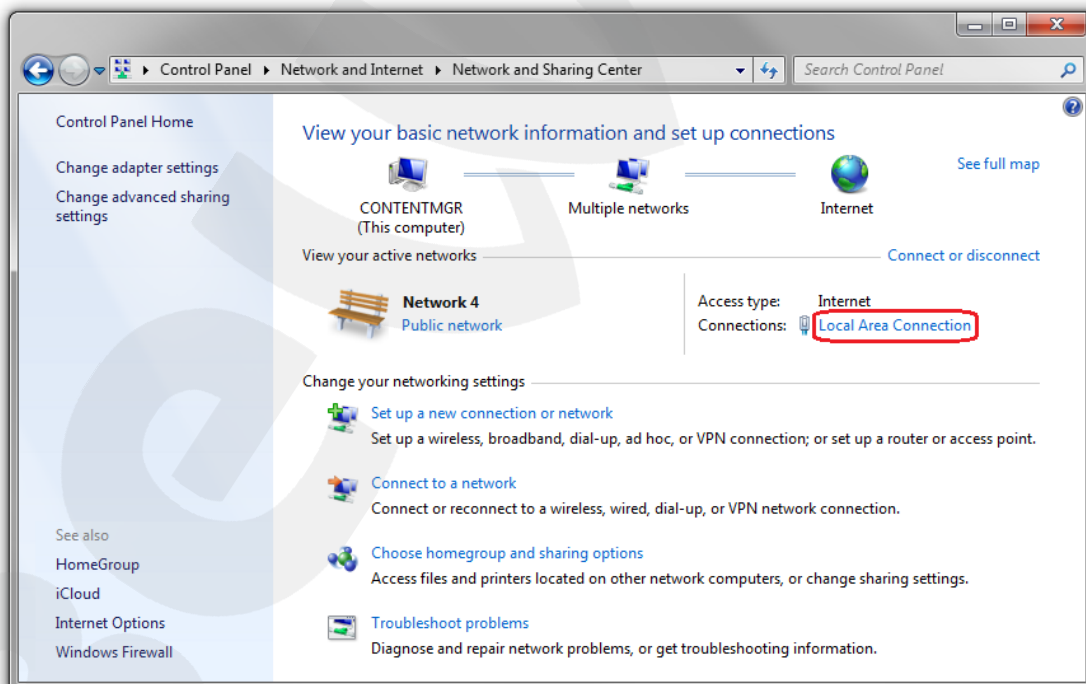

Pic. 5.10

NOTE:

If there are several active networks, choose the one that you are going to connect your camera to.

In the opened window click the [Details] button (Pic. 5.11).

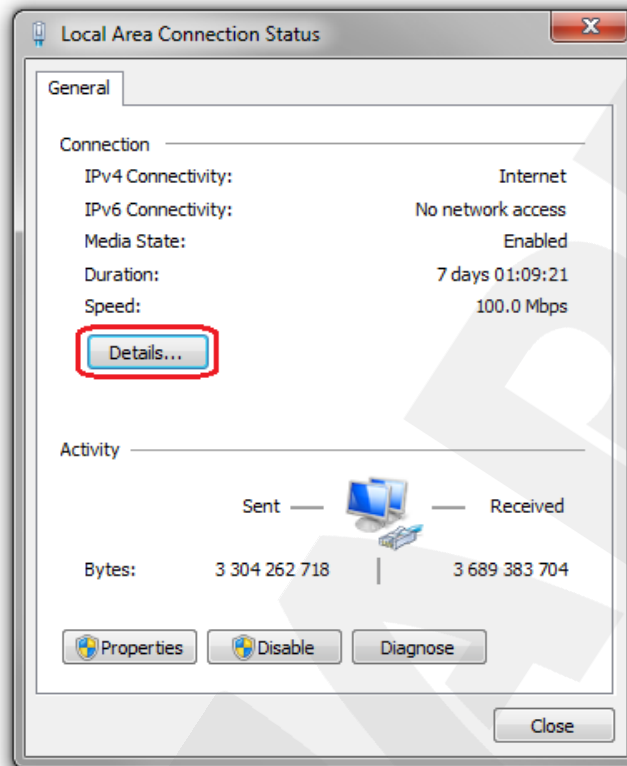

Pic. 5.11

In the opened window you can see the current network connection details (Pic. 5.12).

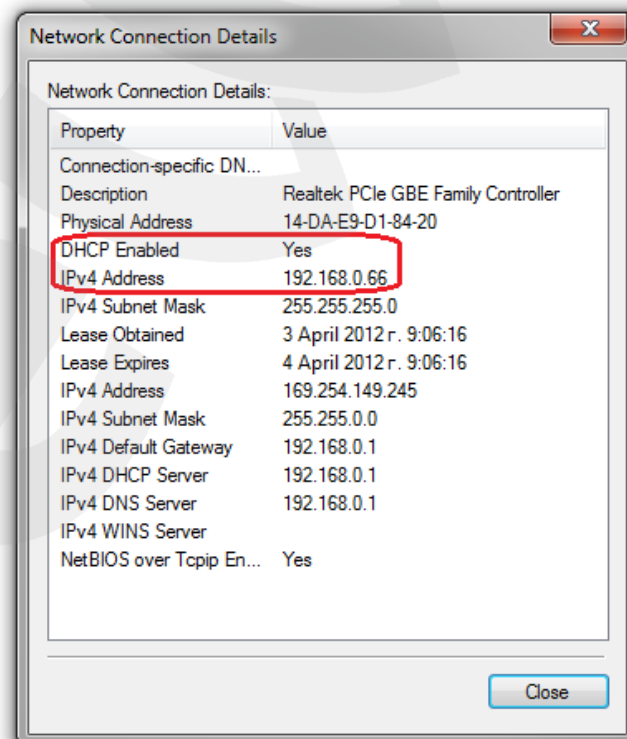

Pic. 5.12

If you will see the following information in the opened window: [DHCP Enabled – Yes], [IPv4 Address – xxx.xxx.xxx.xxx] (where xxx.xxx.xxx.xxx is an IP address value), it means that your computer is assigned the IP address displayed in the [IPv4 Address] line, the subnet mask displayed in the [IPv4 Subnet Mask] line, the gateway address displayed in the [IPv4 Default Gateway] line, the DNS server address displayed in the [IPv4 DNS Server] line. Make a note of these parameters

IMPORTANT!

If you do not make a note of the network parameters, then it will be impossible to return the computer's network settings to their initial state and to connect it to a local network or Internet after configuring N100.

IMPORTANT!

If there is the following information in the **[Network Connection Details]** window: **[DHCP Enabled – Yes], [IPv4 Address Autoconfiguration – xxx.xxx.xxx.xxx]** (where xxx.xxx.xxx.xxx is an IP address value), it means that wired connection was not established and a DHCP-server did not assign your computer an IP address. Please check the connection settings or contact your system administrator.

5.2. Changing the Local Network Parameters

On default IP address of the N100 IP camera is 192.168.0.99. To connect to the camera, you need to get your computer and your camera on the same subnet. Take notice that each device must have a unique IP address.

IMPORTANT!

The camera's default IP address is **192.168.0.99**. If you use several IP cameras, you need to change their default IP addresses to prevent an IP addresses conflict.

IMPORTANT!

If you are sure that your computer and your IP camera are on the same subnet, you can skip this paragraph and go to paragraph [5.3](#).

To change your computer current network settings, go to **Start – Control Panel** (Pic. 5.13).

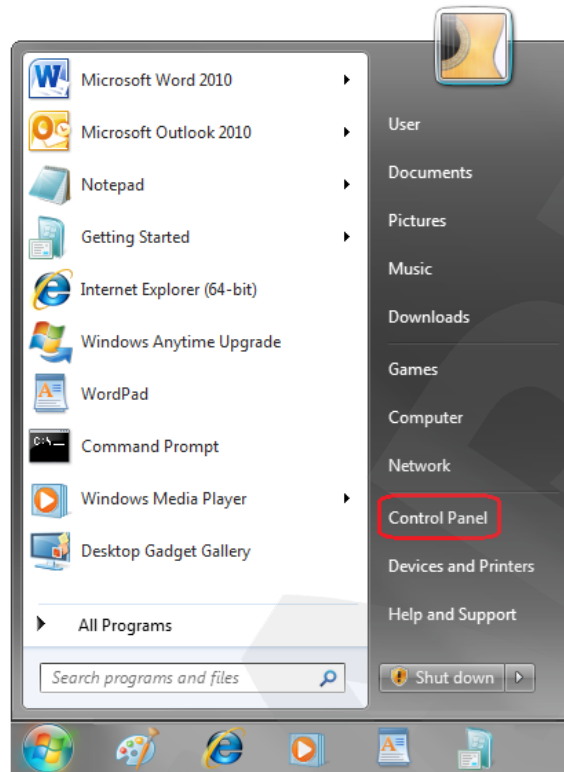

Pic. 5.13

In the opened window click on the **[View network status and tasks]** in the **[Network and Internet]** section (Pic. 5.14).

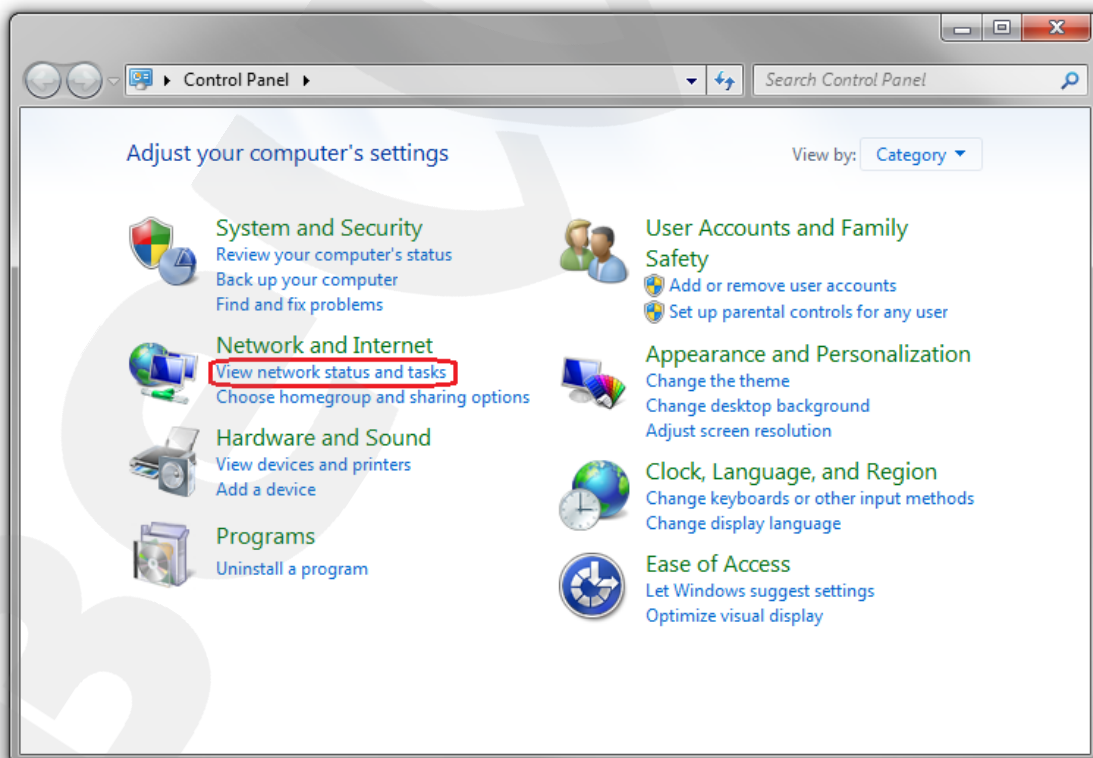

Pic. 5.14

In the opened window, click on the **[Local Area Connection]** (Pic. 5.15).

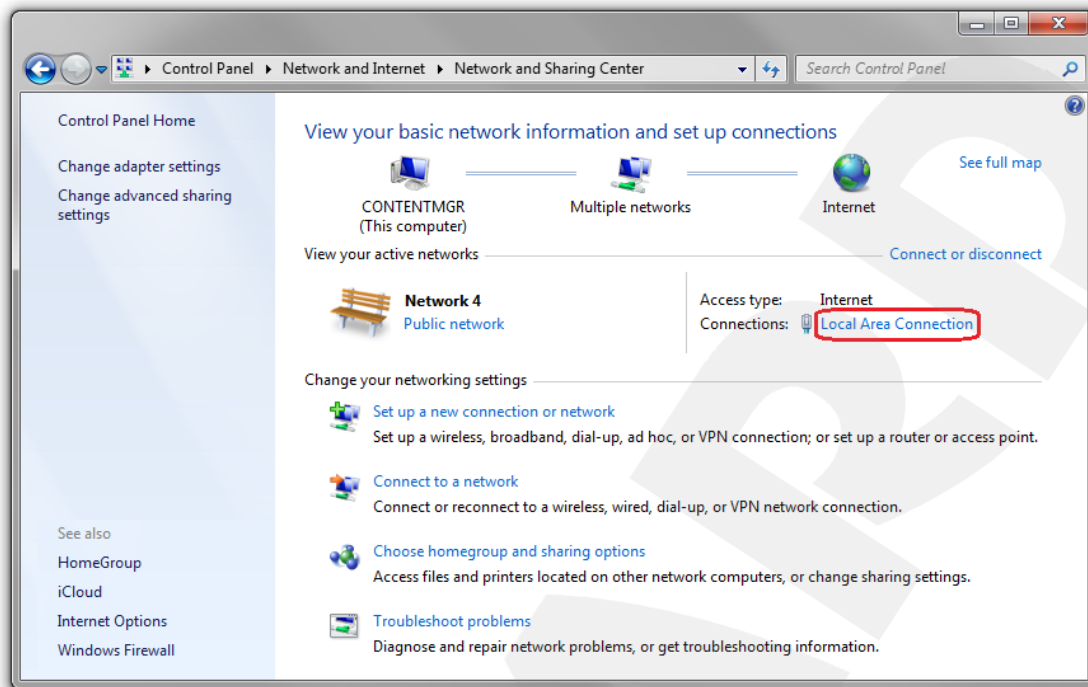

Pic. 5.15

NOTE:

If there are several active networks, choose the one that you are going to connect your camera to.

In the opened window, click the **[Properties]** button (Pic. 5.16).

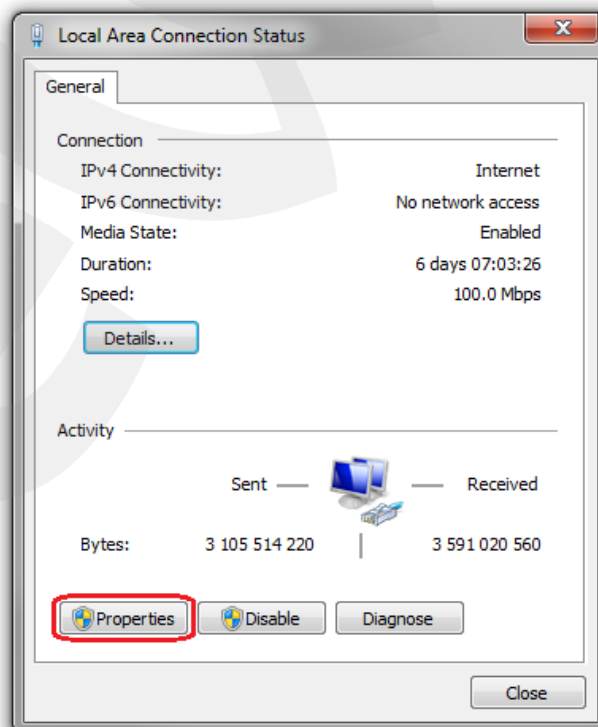

Pic. 5.16

In the connection properties opened window select the **[Internet Protocol Version 4 (TCP/IPv4)]** menu item and click the **[Properties]** button (Pic. 5.17).

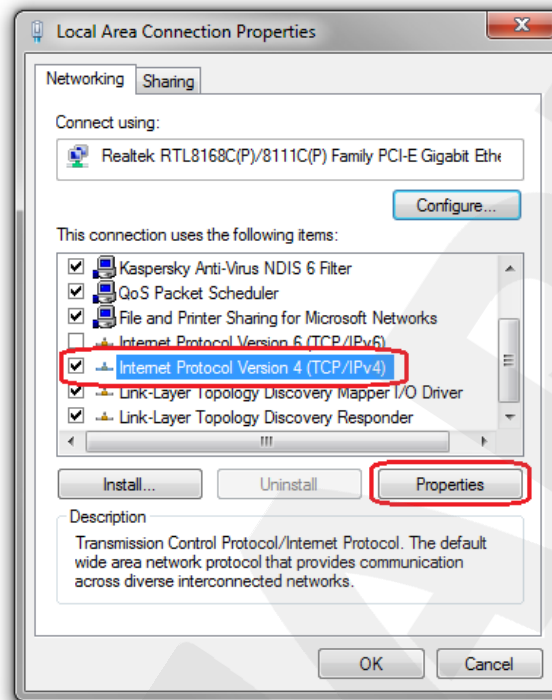

Pic. 5.17

In the opened window you need to specify an IP address and a subnet mask. Click the **[Use the following IP address]** and type an unused IP address from the same subnet as the camera, for example, 192.168.0.20, and 255.255.255.0 in the **[Subnet mask]** field. You can skip the other parameters (Pic. 5.18).

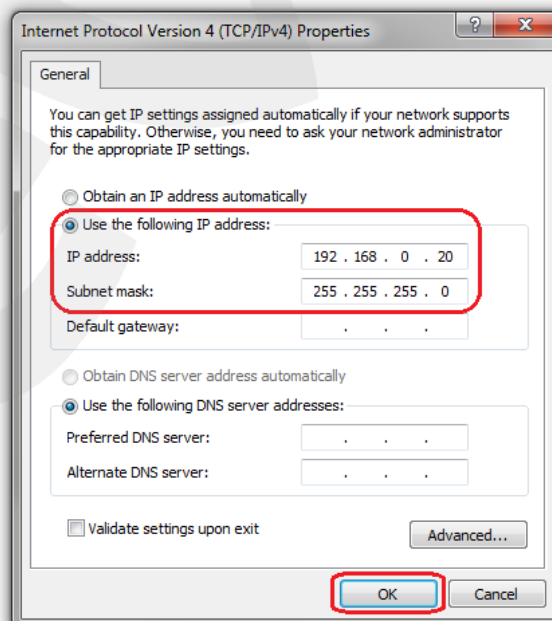

Pic. 5.18

Click the **[OK]** button in the all opened windows to save the changes.

5.3. Accessing the IP Camera

There are three ways to access this IP camera:

- Using “**BEWARD IP Installer**” software;
- Using the **[Network]** menu in Windows 7;
- Using Internet Explorer browser.

IMPORTANT!

When connecting the camera, take notice that the camera’s default IP address is 192.168.0.99.

5.3.1. Installing “BEWARD IP Installer” Software

Insert the supplied CD into your CD-ROM drive. You will see the installation menu (Pic. 5.19).

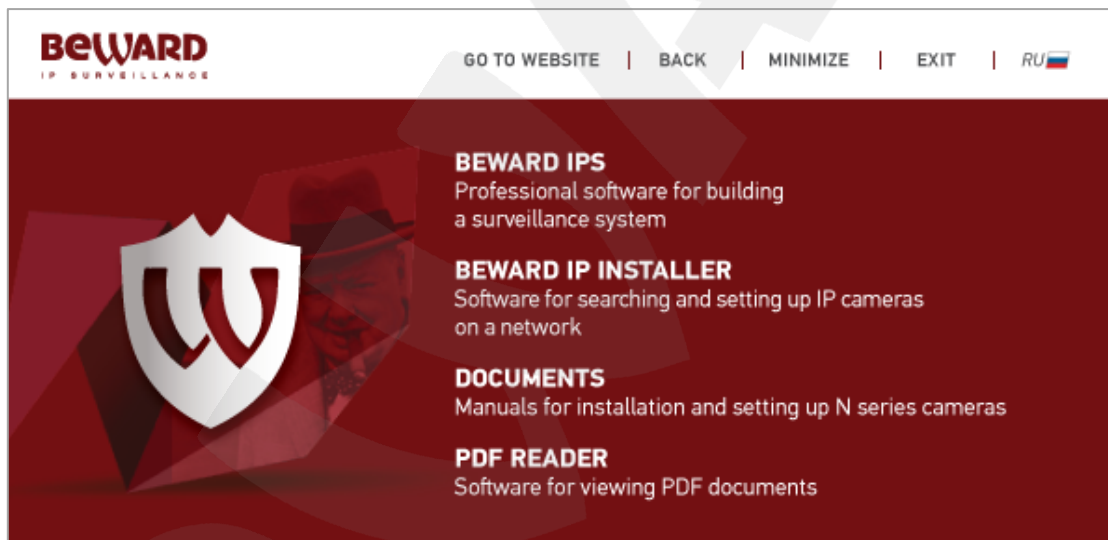

Pic. 5.19

To start the installation, select “**BEWARD IP Installer**” and follow the instructions of the installation wizard till the installation completing (for more details about “BEWARD IP Installer” installation please see BEWARD IP Installer SW User Manual).

5.3.2. Accessing the IP Camera Using “BEWARD IP Installer” Software

IMPORTANT!

To access the IP camera using “**BEWARD IP Installer**” software, a UPnP technology support should be enabled for both your computer and the IP camera. UPnP is enabled by default in Windows 7.

NOTE:

UPnP technology support is enabled by default in the N100 IP camera.

To search for IP cameras through “**BEWARD IP Installer**” software, launch it using the shortcut on your desktop. In the opened window you can see the list of available cameras and video servers. Select your IP camera and click the **[Link to IE]** button (Pic. 5.20).

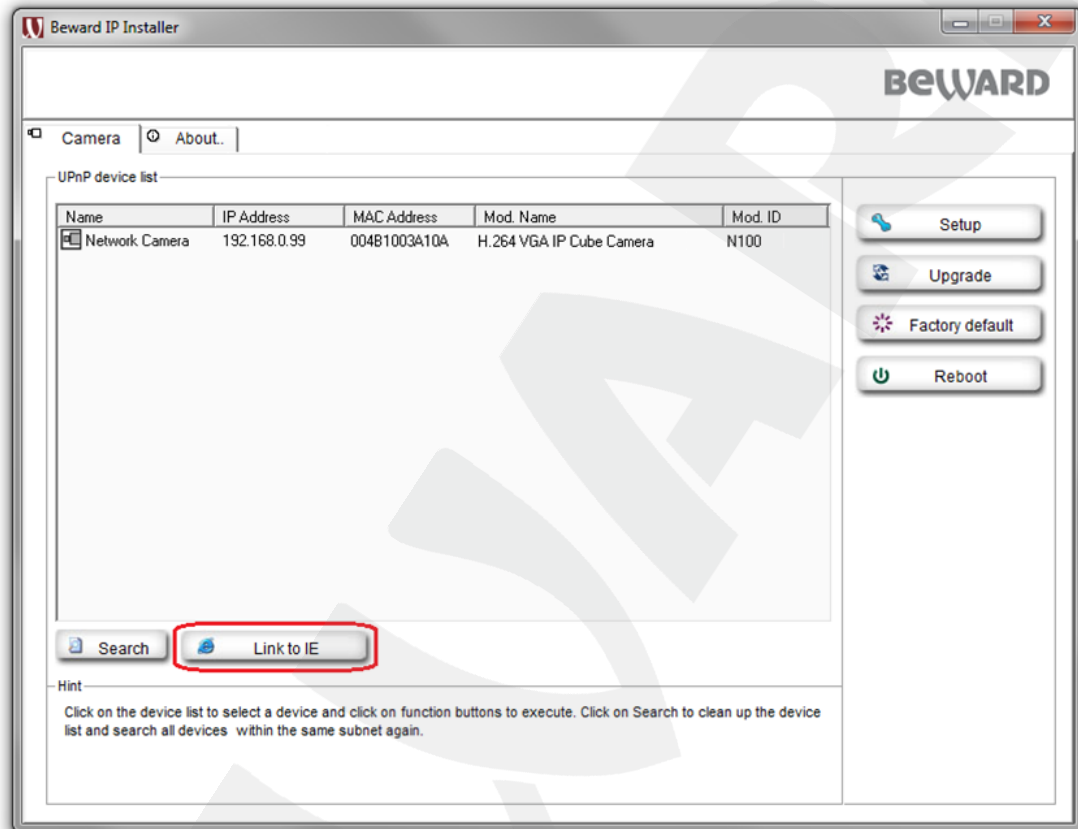

Pic. 5.20

IMPORTANT!

To make “**BEWARD IP Installer**” software work properly, add it to the antivirus and firewall authorized lists.

NOTE:

You may need to run “**BEWARD IP Installer**” as an administrator in order to make it work properly in Windows 7. To do so, right-click the shortcut and select **[Run as administrator]** in the drop-down list.

NOTE:

If an IP camera is missed in the UPnP device list, click the **[Search]** button to refresh it (Pic. 5.20).

5.3.3. Accessing the IP Camera Using the Network Menu in Windows 7

NOTE:

The UPnP technology support is enabled in the N100 IP camera by default.

To search for N100 through the **[Network]** menu in Windows 7, go to the **[Computer]** menu and click the **[Network]** tab (*Pic. 5.21*).

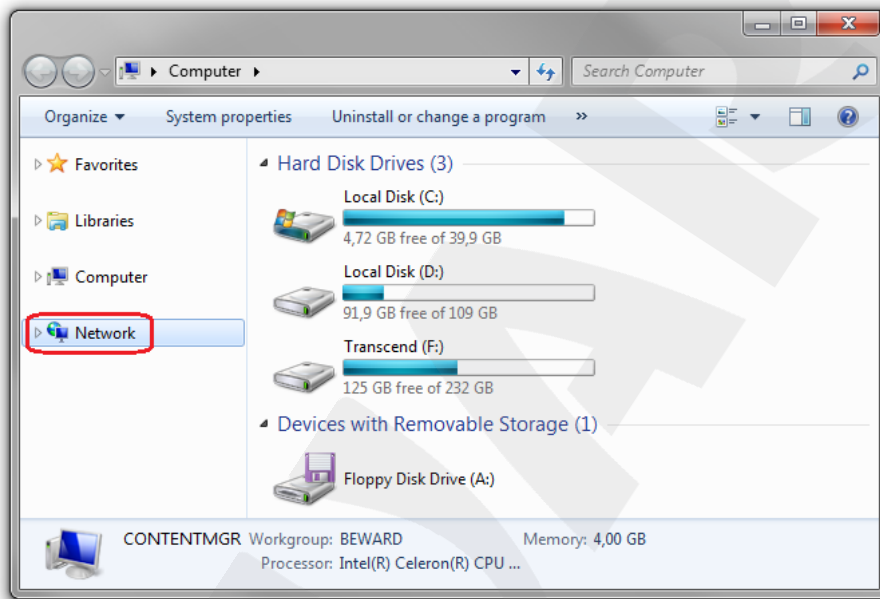

Pic. 5.21

In the appeared window, find the camera and double-click it with the left mouse button (*Pic. 5.22*).

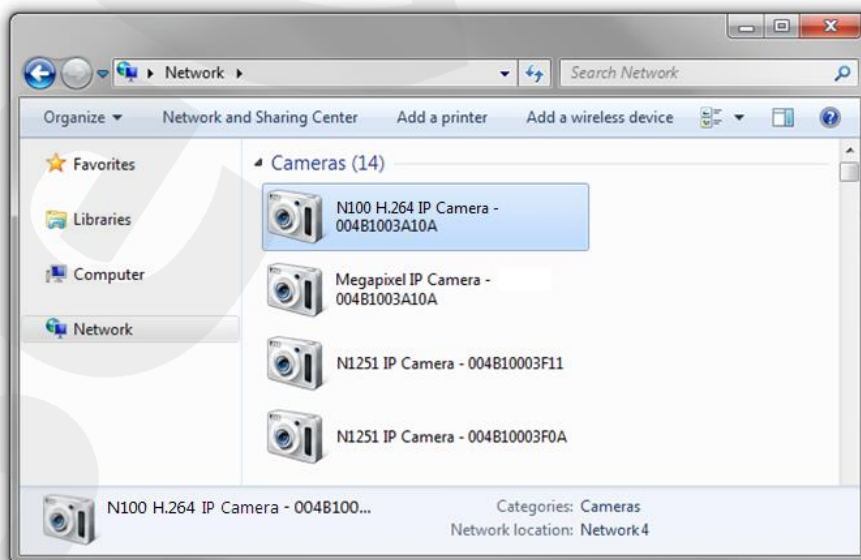

Pic. 5.22

This will open the camera's web interface in the browser that is set as default where you can configure the camera and view the images.

5.3.4. Accessing the IP Camera Using Internet Explorer

To access this camera through Internet Explorer, launch the browser and enter the following in the address field: `http://<IP>:<port>/`, where **<IP>** is the IP address of the camera, **<port>** is the number of the port that is used for HTTP connection to the camera (*Pic. 5.23*).

IMPORTANT!

On default the IP address of N100 is 192.168.0.99 and the http-port is 80.

NOTE:

You do not need to enter a port number if you are connecting through the default HTTP port 80.

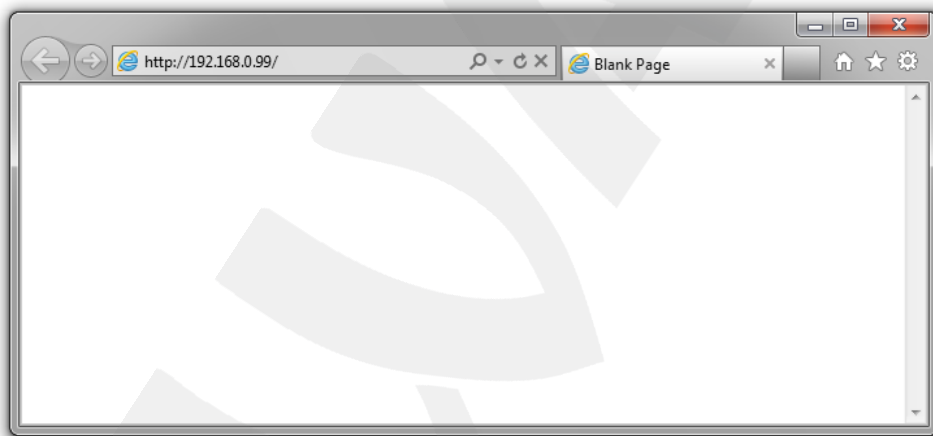

Pic. 5.23

5.4. Accessing the Camera's Web Interface

As you have accessed the camera using any of the ways described in paragraphs [5.3.2 – 5.3.4](#), Internet Explorer will be launched and an authorization window will appear.

NOTE:

Use of the camera's web interface requires Internet Explorer 9.0 or later to run and display correctly.

Enter a username and a password, then click **[OK]** (*Pic. 5.24*).

IMPORTANT!

On default a username is **admin** and a password is **admin**.

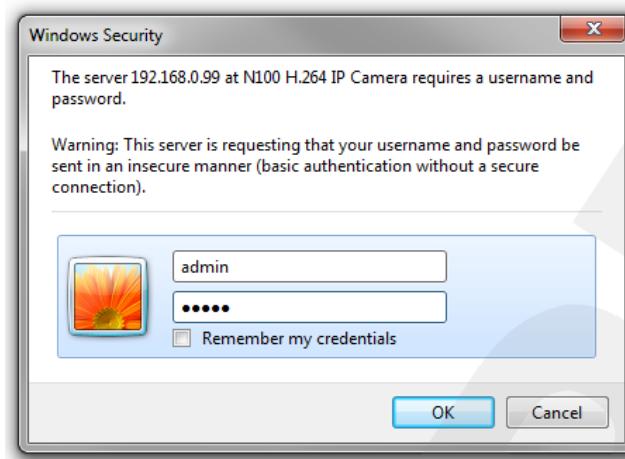

Pic. 5.24

After the first successful authorization, Windows 7 blocks the ActiveX add-on (is used for work with the camera's web interface) installation on default. You will see a system notification at the bottom of the window: **“This webpage wants to run the following add-on: “AxMediaControl ActiveX Control Module” from “BEWARD Co., Ltd.”** (Pic. 5.25).

Click **[Allow]** button to continue the installation.

IMPORTANT!

Installation of ActiveX components is possible to 32-bit Internet Explorer only.

NOTE:

In the other operating systems and browsers, menu titles or system notifications may be differ from the same in the systems/browsers of Windows family. This note is applicable to different versions of operating systems and browsers within Windows family also.

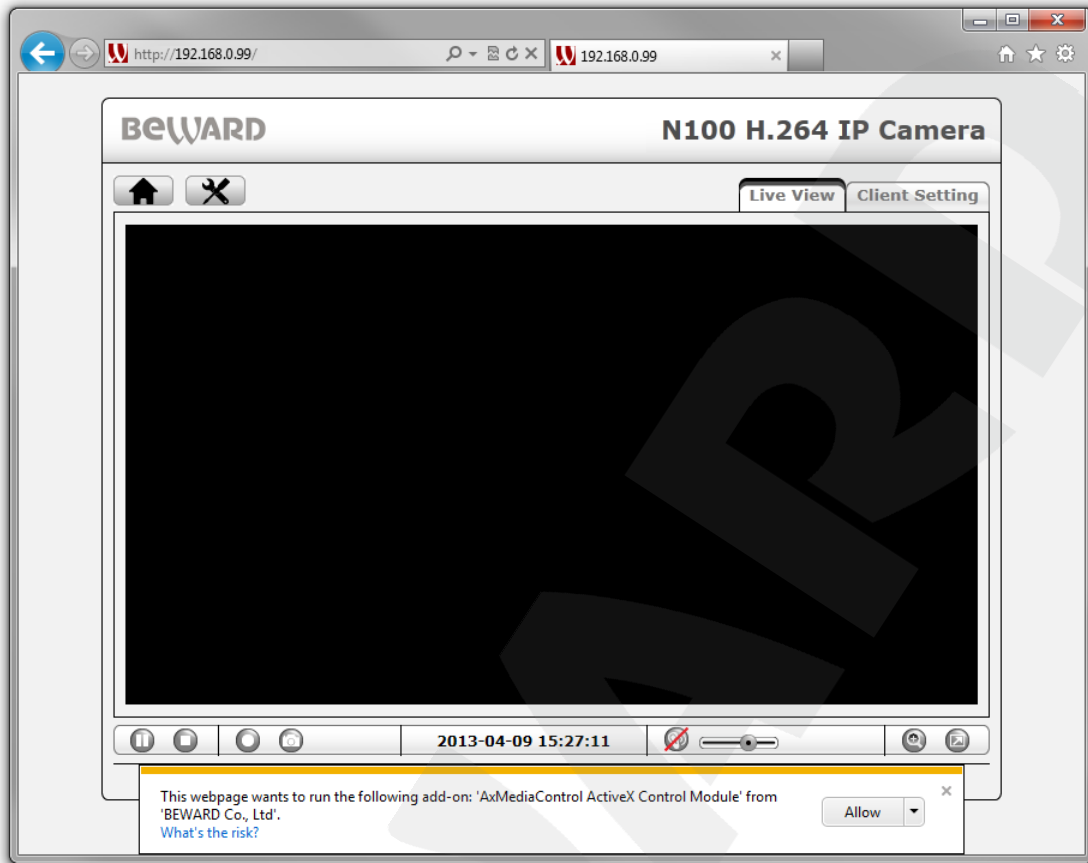

Pic. 5.25

On default, Internet Explorer security system blocks ActiveX components installation too. Click **[Install]** to continue (Pic. 5.26).

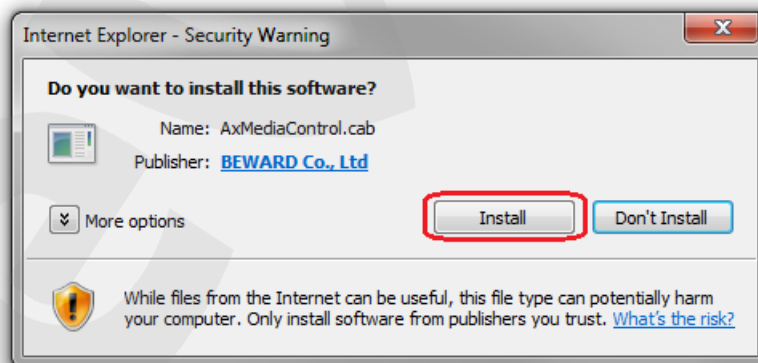

Pic. 5.26

NOTE:

There will be additional installation blocking when installing ActiveX components in Windows 7 with enabled user account control. In this case you will see an additional system notification. To permit installation you should give a positive answer in the appeared window.

If everything was done correctly, you get the camera image on your display (*Pic. 5.27*).

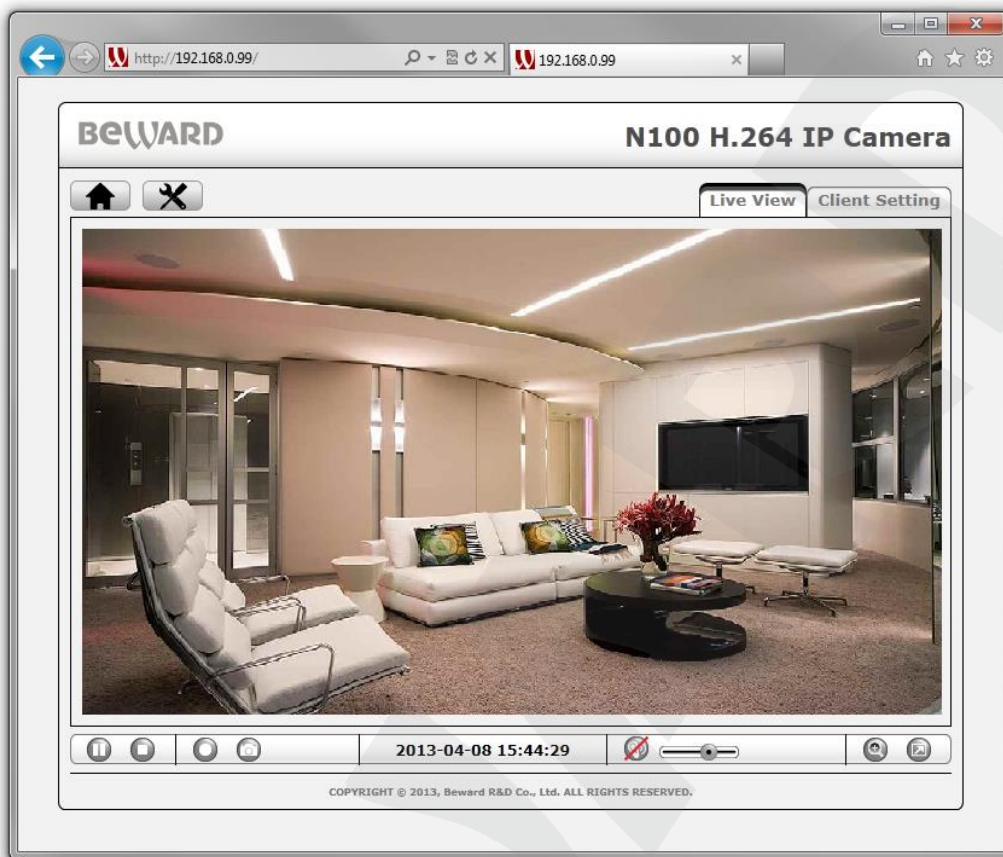

Pic. 5.27

5.5. Configuring the Camera's Network Settings through the Web Interface

After connecting the N100 to the local network you need to change its network parameters to get it and your other devices (e.g. computer, laptop etc.) to the same subnet.

IMPORTANT!

To make your camera and your computer work together, the first three parts of their IP addresses must be identical but the fourth must differ.

For example, the IP address of your computer is 192.168.50.40. An IP address consists of four octets separated by dots. In the provided example, the 1st octet is 192, the 2nd octet is 168, the 3rd octet is 50, and the 4th octet is 40. You need to change the IP address of your camera so that the first three octets of its IP address were the same as your computer's IP address. Therefore, the IP address of your camera must be of the form 192.168.50.XX. You only need to change the fourth octet to a number different from the IP address of your computer and other network devices.

To configure the network settings through the web interface, click the  [SETTING] button and go to the **Network - Basic** (*Pic. 5.28*).

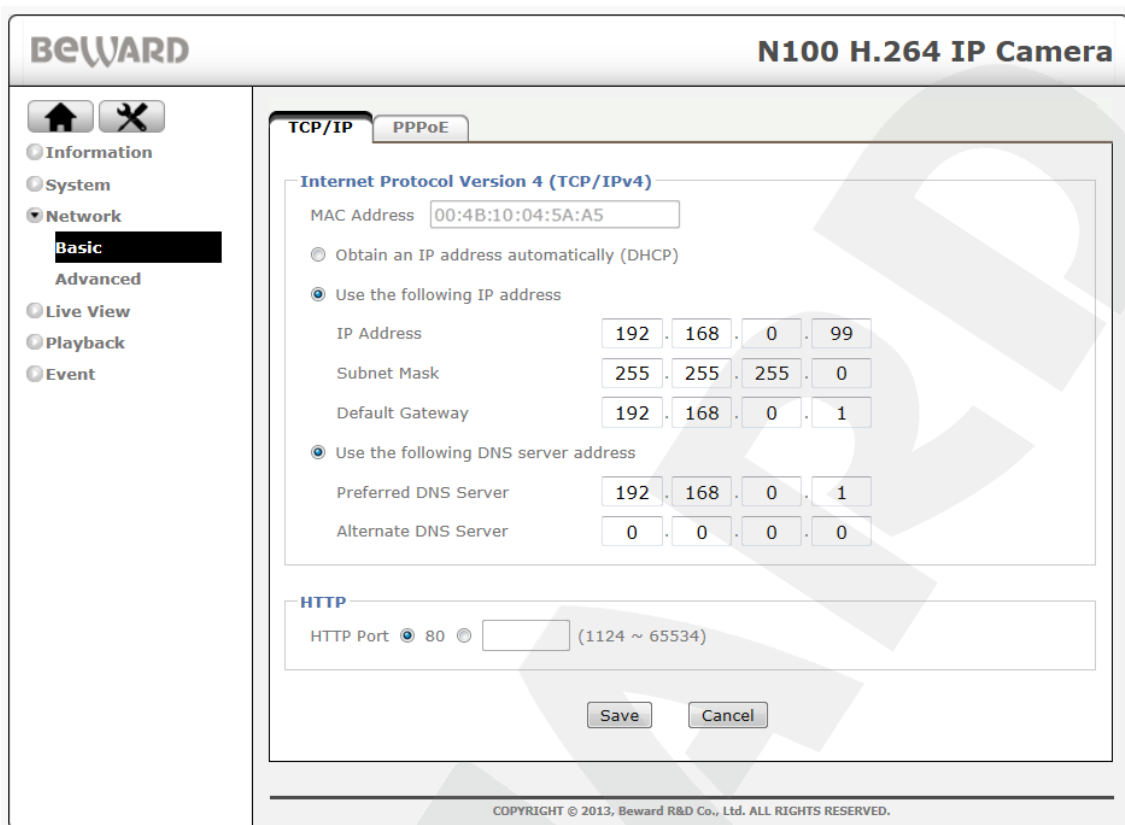

Pic.5.28

In the **[TCP/IP]** subsection you need to enter such values of the IP address and other network parameters that it provided joint work of the camera and other devices in the same subnet (Pic. 5.28).

NOTE:

Contact your system administrator if you need assistance.

Click **[Save]** to save the changes.

Configuring the camera's network settings is completed.

5.6. Restoring the Network Settings of the Computer to Their Previous Values

To restore the wired connection settings to their previous values, follow the steps below.

Go to **Start – Control Panel** (Pic. 5.29).

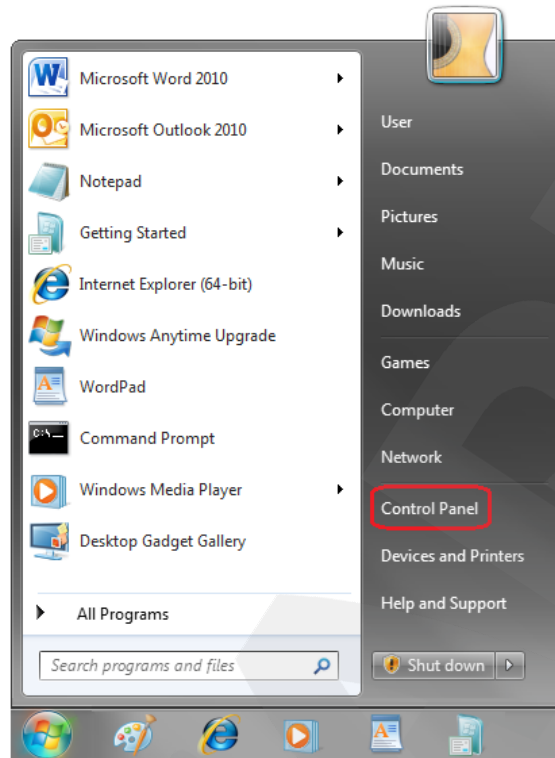

Pic. 5.29

In the opened window, click on the **[View network status and tasks]** in the **[Network and Internet]** section (Pic. 5.30).

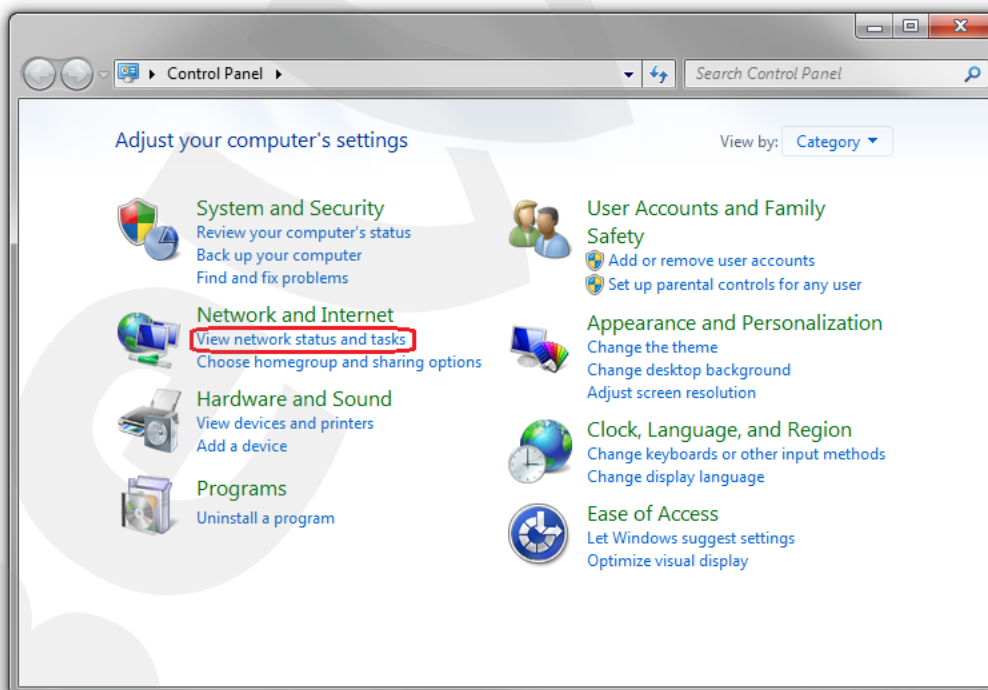

Pic. 5.30

In the opened window, click on the **[Local Area Connection]** (Pic. 5.31).

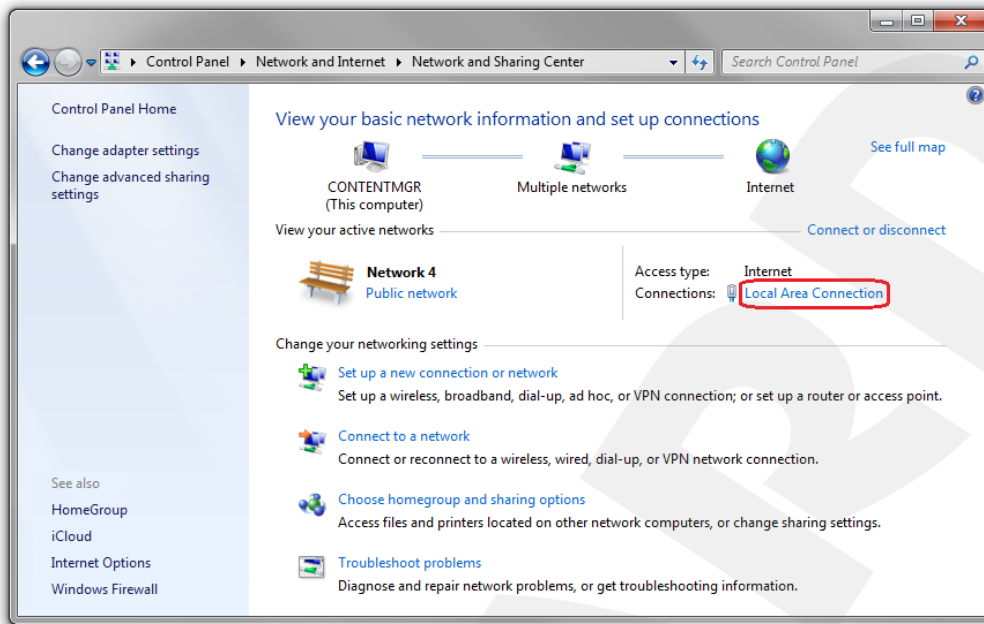

Pic. 5.31

In the opened window, click the **[Properties]** button (Pic. 5.32).

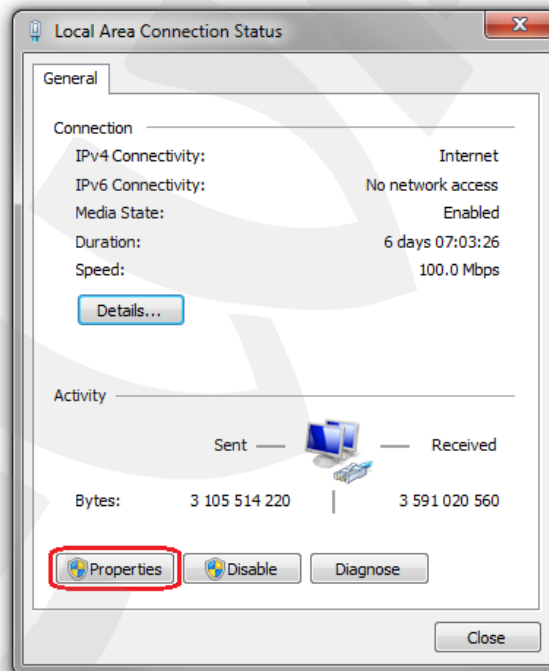

Pic. 5.32

Select the **[Internet Protocol Version 4 (TCP/IPv4)]** menu and click the **[Properties]** button (Pic. 5.33).

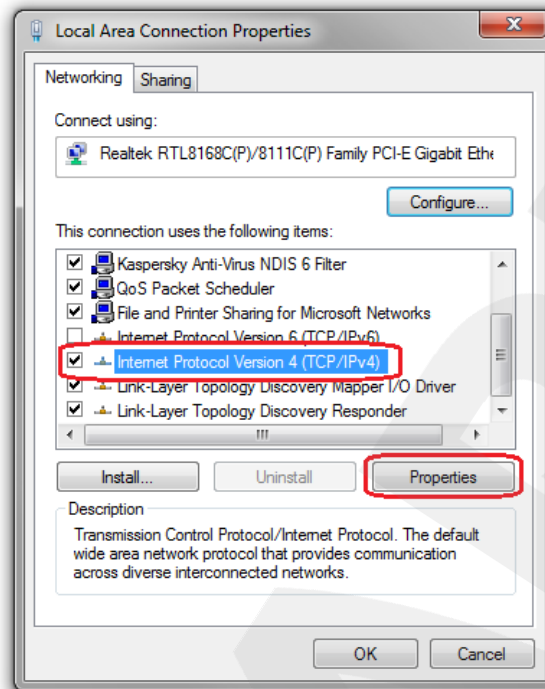

Pic. 5.33

In the opened window of the connection properties you need to specify your initial network settings (see paragraphs [5.1](#), [5.1.1](#)).

If the IP settings were assigned automatically, use the **[Obtain an IP address automatically]** and the **[Obtain DNS server address automatically]** options (Pic. 5.34), then click **[OK]**.

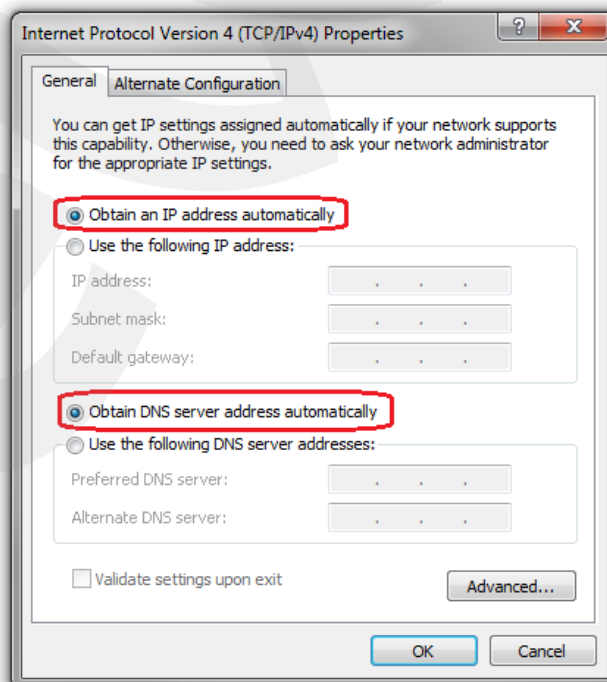

Pic. 5.34

If the IP settings were specified manually, use the **[Use the following IP address]** and the **[Use the following DNS server addresses]** options and complete the required fields (see paragraph 5.1), then click **[OK]** (Pic. 5.35).

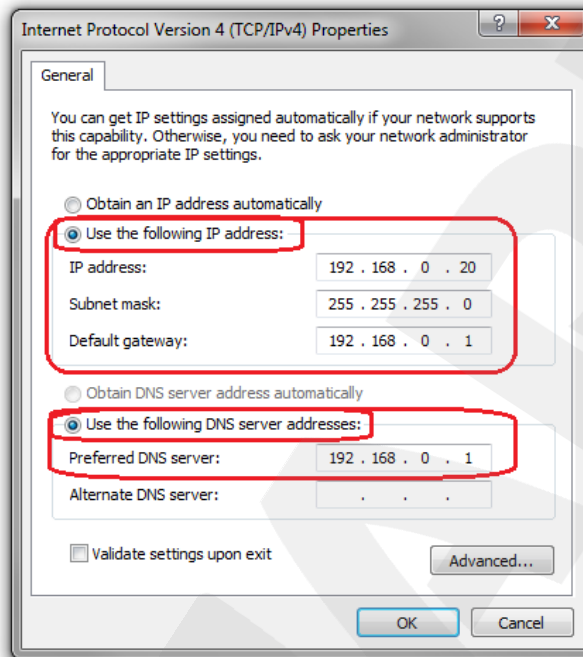

Pic. 5.35

5.7. Verifying the Connection Settings

To verify the network settings of your camera and your computer, you must access the camera through Internet Explorer.

To launch Internet Explorer go to **Start – All Programs** and click **[Internet Explorer]**.

Enter your camera's IP address in the address field (e.g. `http://192.168.0.99`) (Pic. 5.36).

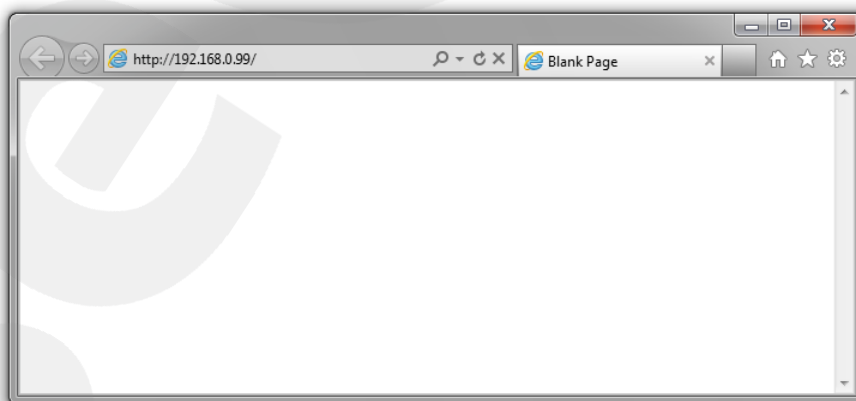

Pic. 5.36

If the settings are correct, an authorization window will appear. Enter the username and password, then click **[OK]** (Pic. 5.37).

IMPORTANT!

The default username is **admin**, the default password is **admin**.

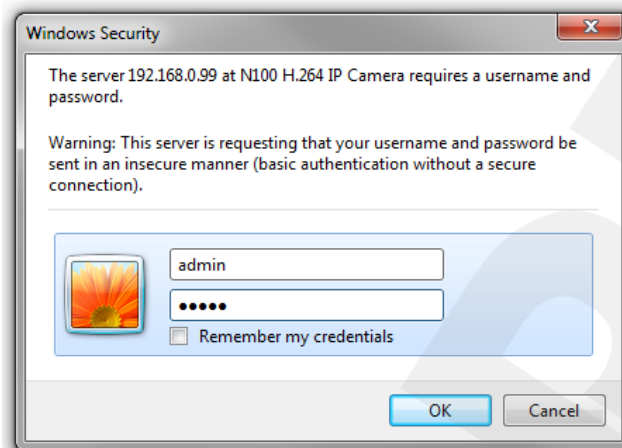

Pic. 5.37

If everything was done correctly, you see the camera image on your display (Pic. 5.38).

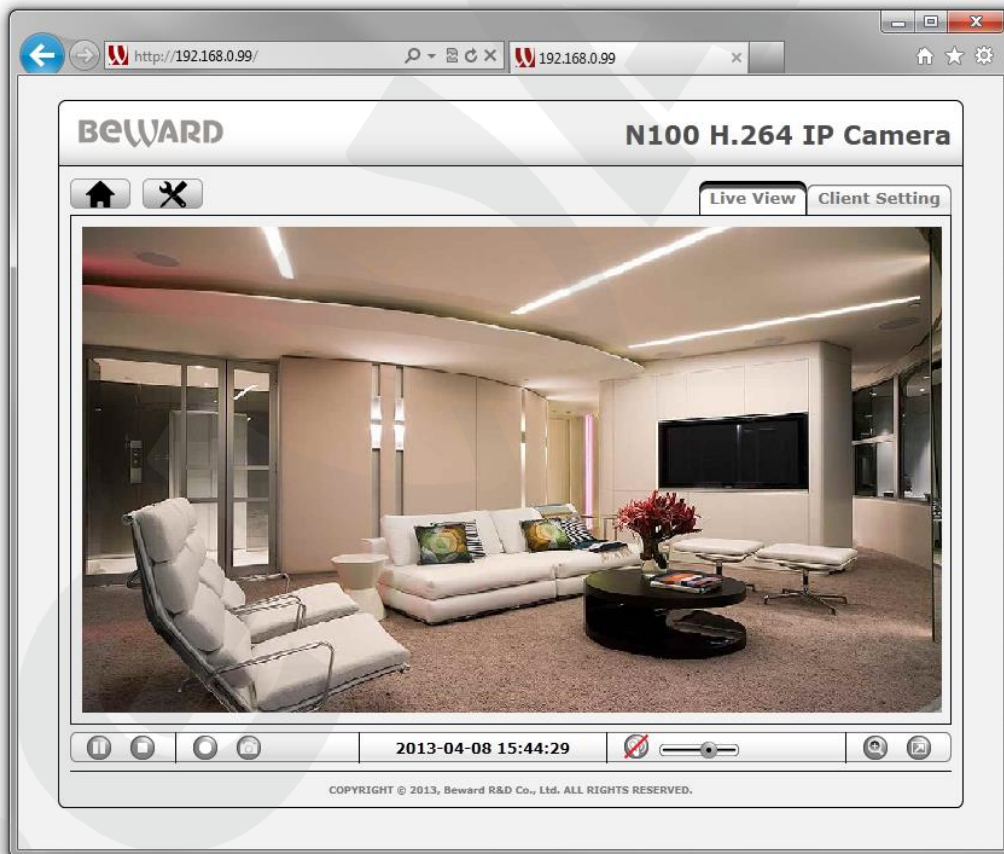

Pic. 5.38

NOTE:

If the camera image is not appeared on your display, return to the chapter's [beginning](#) and check the setting step by step. Contact your system administrator if you need assistance.

Chapter 6. Accessing the Camera over Internet

6.1. Overview of Internet Access to the Camera

When installing an IP camera in apartments, a cottage, or an office, most users want to be able to access the camera and view the images over a local network as well as over the Internet.

This requires a router to provide your camera, your computer and other devices with Internet access and make them work together.

There are three most common ways to connect this IP camera to the Internet:

- There is an external static IP address or PPPoE connection. Such an IP address (or PPPoE connection) can be used to connect only one camera to view the images over the Internet. This type of networking does not allow sharing a single IP address among several devices.
- There is an external static IP address that is used to connect a LAN to the Internet and assigned to one or several cameras to view the images over the Internet. This type of networking requires the use of a router. Therefore, the number of connected cameras depends on how many ports are on the router.
- There is a temporary dynamic IP address, which can change during a session. This type of networking allows connecting multiple cameras to view the images over the Internet regardless of the IP address they are assigned and requires the use of dynamic DNS services.

The possible ways of accessing the camera over the Internet are considered below.

6.2. Using an External Static IP Address or PPPoE Connection

6.2.1. Using an External Static IP Address

To connect your IP camera to the Internet, change the network settings of the IP camera according to the settings provided by your ISP (Internet Service Provider). Most ISP's provide the following parameters: an IP address, a subnet mask, a network gateway, and a DNS server address.

To access the IP camera over the Internet using a static IP address, follow the steps below:

Step 1: connect the IP camera to your computer directly.

Step 2: change the network settings of the IP camera (see paragraph [5.5](#)) according to the settings provided by your ISP (*Pic. 6.1*).

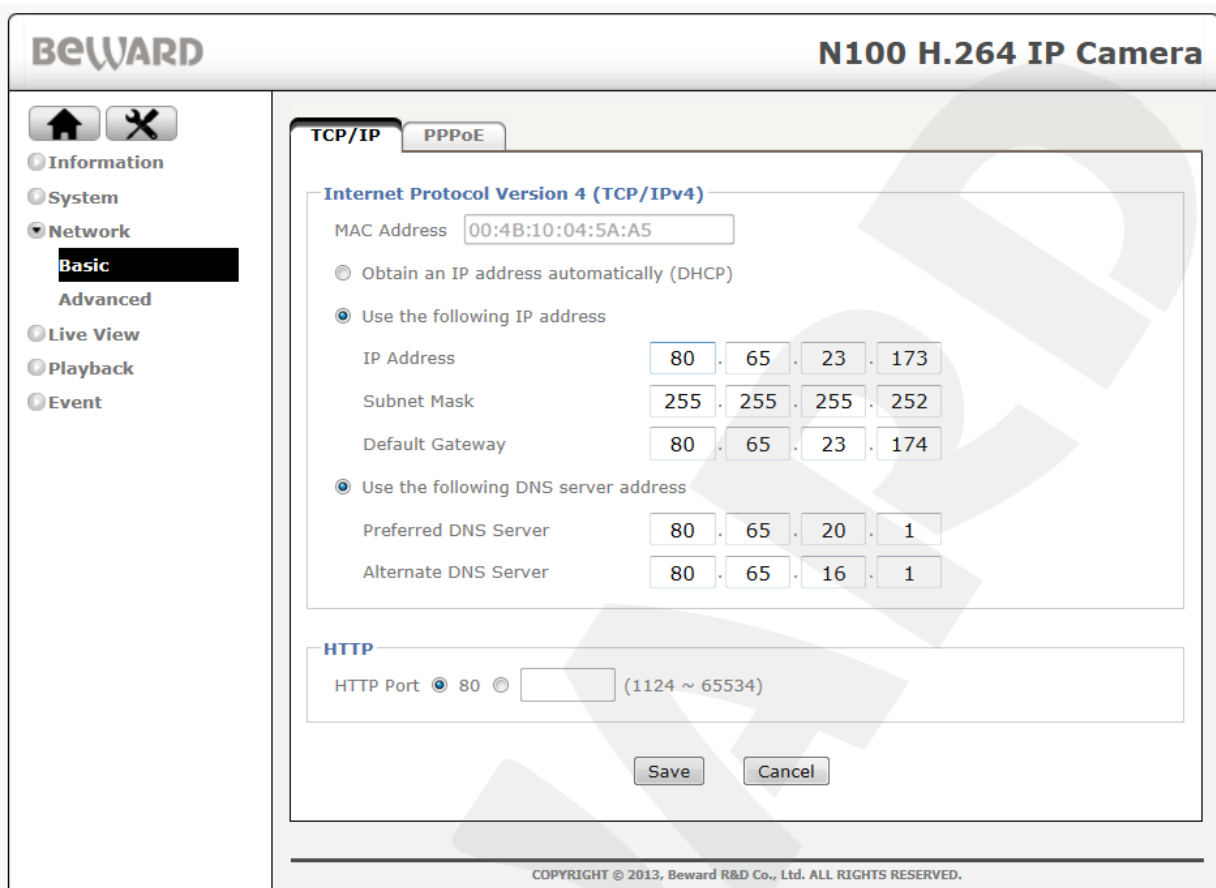

Pic. 6.1

Step 3: connect the IP camera to the Ethernet network.

If everything is configured properly, the camera should be available over the Internet.

The following settings were used in the provided example:

IP address: 80.65.23.173

Subnet mask: 255.255.255.252

Default gateway: 80.65.23.174

Preferred DNS server: 80.65.20.1

Alternate DNS server: 80.65.16.1

To access the camera over the Internet, enter the following in the address field of your browser: **http://<IP>:<Port>**, where **<IP>** is the IP address of the camera, **<Port>** is the port number that is used for HTTP connection to the camera (the default value is 80). In the provided example, the following should be entered in the address field: **http://80.65.23.173**.

NOTE:

You do not need to enter a port number if you are connecting through the default HTTP port 80.

6.2.2. Using a PPPoE Connection

If your ISP cannot provide a static IP address, you can use a PPPoE connection to access the camera over the Internet. To access the camera over a PPPoE connection, you should take a **username** and a **password** from your ISP.

The N100 supports PPPoE connection. Follow the steps below to establish the connection:

Step 1: connect the IP camera to your computer directly.

Step 2: click the  [SETTING] button and go to **Network – Basic – PPPoE**.

Step 3: turn it on and enter the network settings provided by your ISP (Pic. 6.2).



Pic. 6.2

Step 4: click [Save] to save the changes.

IMPORTANT!

To apply new settings you need to reboot the camera.

Step 5: connect the IP camera to the Ethernet network.

IMPORTANT!

After being connected to the Ethernet, the camera is available at the IP address assigned by your ISP. To access the camera, you can use DynDNS service, which allows accessing the camera over the Internet when using a PPPoE connection (for more details see paragraph [6.4](#)).

To access the camera over the Internet, enter the following in the address field of your browser: **http://<IP>:<Port>**, where **<IP>** is the IP address of the camera that is used for PPPoE connection, **<Port>** is the port number that is used for HTTP connection to the camera (the default value is 80).

NOTE:

You do not need to enter a port number if you are connecting through the default HTTP port 80.

6.3. Internet Access to the Camera on a Local Network

When a leased line or ADSL is used for Internet access, a router is necessary to establish a local network.

IMPORTANT!

This type of connection requires a static public IP address. Usually ISPs provide a dynamic internal IP address, which can be used only inside the LAN. Contact your ISP to determine your IP address type.

To access the camera over the Internet, use the IP address provided by your ISP (IP address of the router's WAN port) and a certain port number.

IMPORTANT!

When accessing over the Internet, you should note that all cameras inside the local network have the same public IP address. To access the cameras through the same IP address, you must specify a unique HTTP port number for each camera.

In this case, you should do the following:

- Configure the network settings of the IP cameras according to your LAN settings (see paragraph [5.5](#)).
- Allow external connections. This can be done by configuring the “**Virtual server**”, which allows directing any external requests reached a predefined WAN port to the camera's IP address on the local network. Most modern routers have the “**Virtual server**” option.

To provide Internet access to your camera(s) through a router, there are two following methods to configure the routing:

- Using UPnP in your camera and your router.
- Manually configuring a routing table.

6.3.1. Using the UPnP Option

Before using UPnP, make sure your router supports port forwarding between LAN and WAN networks. If so, follow the steps below to provide the Internet access to your camera:

- Enable UPnP on your router and configure it.

IMPORTANT!

Some routers do not support port forwarding between LAN and WAN networks over UPnP. Before configuring, make sure your router supports this option. If not, additional setting is required.

- Enable UPnP on your camera and configure it.

See your router's user manual for details on how to enable and configure the UPnP.

To enable and configure UPnP on your camera, follow the steps below:

Step 1: enable UPnP on your camera. To do so, click the  [SETTING] button and go to **Network – Advanced – UPnP**.

Step 2: check the [Turn On UPnP port forwarding] (Pic. 6.3).

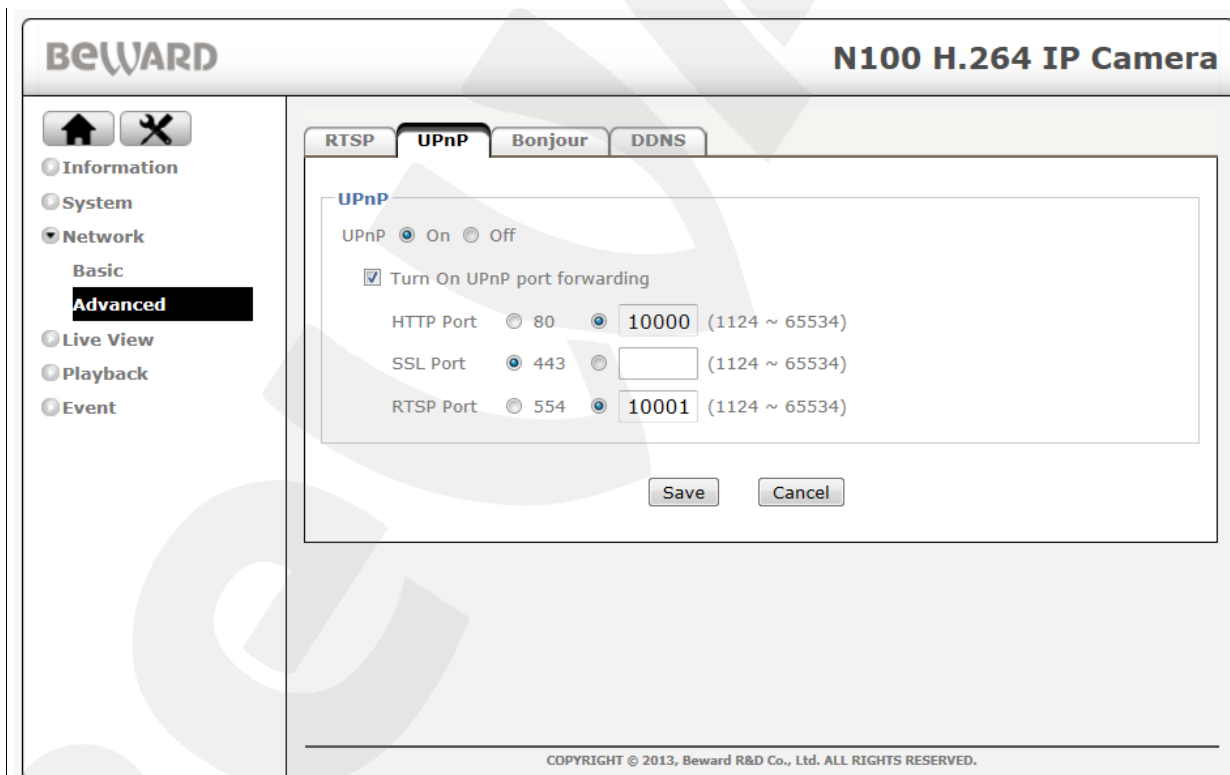

Pic. 6.3

Step 3: in the [HTTP port] field, enter the HTTP port number that you want to use to access the camera over the Internet. For example, the value of the port you assigned is 10000. In this case, port 80 is used to access the camera over a local network and port 10000 is used to access the camera over the Internet.

Step 4: in the **[RTSP port]** field enter the RTSP port number that you want to use to access the camera over the Internet.

Step 5: click **[Save]** to save the changes.

IMPORTANT:

It is necessary to reboot the camera for the changes to take effect.

IMPORTANT:

When using port forwarding, the port number values of the camera and the router must match.

To access the camera over the Internet, use the IP address provided by your ISP (IP address of the router's WAN port) and a certain port number.

For instance, the WAN IP address is 77.108.73.169 and the HTTP port number is 10000. In this case, you need to enter the following in the address field of your browser: `http://77.108.73.169:10000/`.

To use several cameras, you need to specify a unique port number for each one and configure the port forwarding.

6.3.2. Manual Port Forwarding

If your router does not support UPnP, you must configure your router manually to forward the ports. To describe this way of connecting the IP camera, use the TP-Link TL-WR2543ND router.

IMPORTANT!

This type of connection requires a static public IP address. Usually Internet service provider (ISP) offers a dynamic internal IP address, which can be used only inside the LAN. Contact your ISP to determine your IP address type.

Let us suppose that Internet and LAN connections are configured on your router. The router's static public IP address provided by your ISP is 77.108.73.169.

The IP address range used on the local network is 192.168.1.1 – 192.168.1.255. The router's IP address is 192.168.1.1 and the camera's IP address is 192.168.1.199. For setting, we use a computer connected to this local network.

To access the camera over the Internet, you need to configure its ports. On the local network the port numbers used for accessing camera's settings and video on default are the following: HTTP port – 80, RTSP port – 554.

IMPORTANT!

When accessing over the Internet, you should note that all cameras inside the local network have the same public IP address (the IP address assigned by your ISP). To access the cameras through the same IP address, you must specify the unique port numbers for each camera.

Follow these steps to change the ports of the camera:

IMPORTANT!

It is acceptable to share the same HTTP port between your IP cameras using port forwarding on the virtual server. However, you must specify a unique RTSP port number for each camera in order to access them over the Internet.

Step 1: go to  **[SETTING] – Network – Advanced – RTSP.**

Step 2: in the **[RTSP port]** field, enter the RTSP port number that is different from the default one. For this example, we use the RTSP port 3001 (Pic. 6.4).

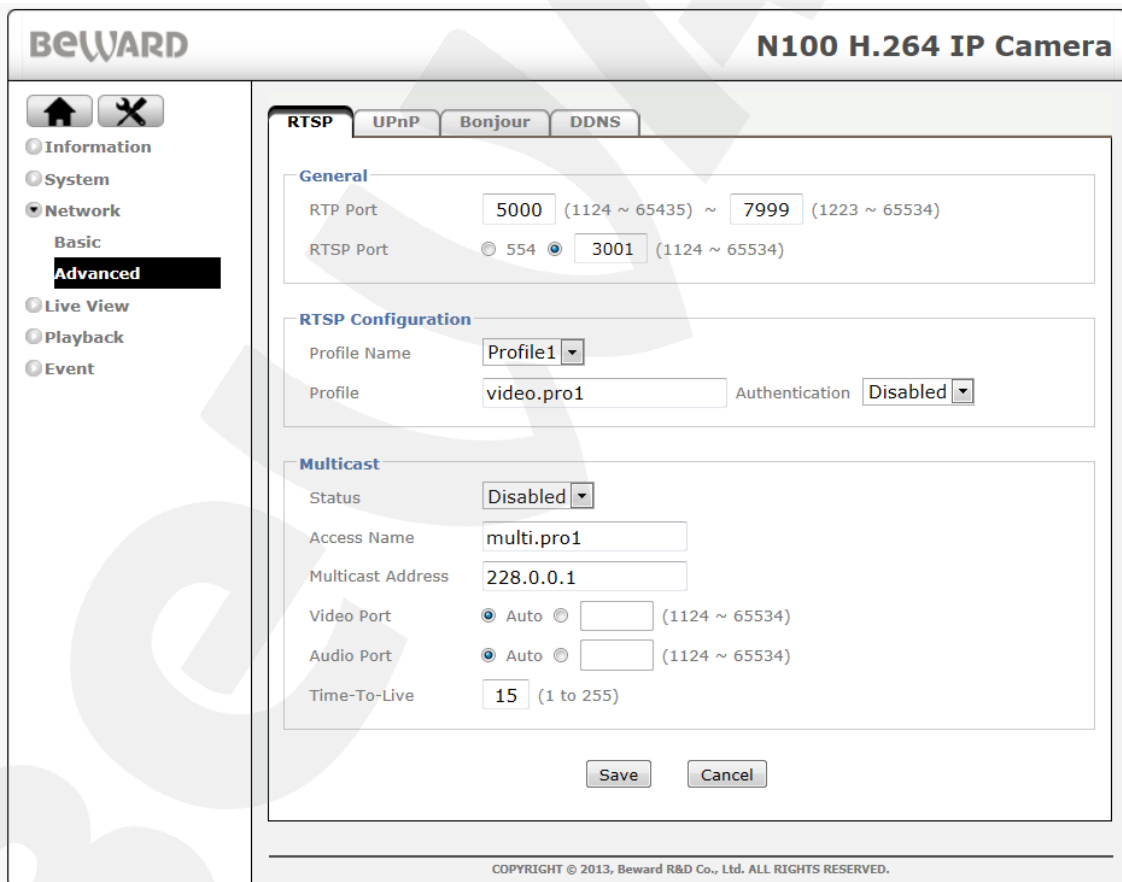

The screenshot shows the web interface for the BEWARD N100 H.264 IP Camera. The left sidebar contains navigation options: Information, System, Network (Basic, Advanced), Live View, Playback, and Event. The main content area is titled 'RTSP' and includes tabs for UPnP, Bonjour, and DDNS. The 'General' section shows RTP Port set to 5000 and RTSP Port set to 3001. The 'RTSP Configuration' section shows Profile Name as 'Profile1' and Profile as 'video.pro1'. The 'Multicast' section shows Status as 'Disabled', Access Name as 'multi.pro1', Multicast Address as '228.0.0.1', Video Port as 'Auto', Audio Port as 'Auto', and Time-To-Live as '15'. 'Save' and 'Cancel' buttons are located at the bottom of the configuration area.

Pic. 6.4

Step 3: click **[Save]** to save the changes.

For the next camera you can specify as follows: HTTP port 80, RTSP port 3002.

Now you need to **configure your router** to make the camera accessible over the Internet. To do so, follow the steps below:

Step 1: enter the IP address of your router in the browser address field (here, the IP address is 192.168.1.1). In the appeared window, enter your username and your password. After successful authorization, the router settings page appears (*Pic. 6.5*).

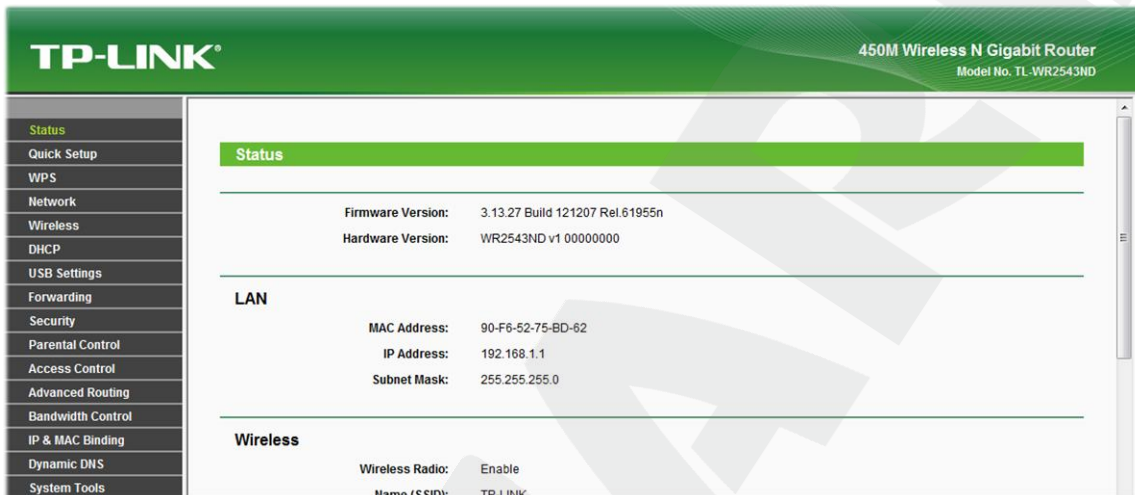

Pic. 6.5

Step 2: go to **Forwarding – Virtual Servers**. Click the **[Add New]** in the opened menu (*Pic. 6.6*).

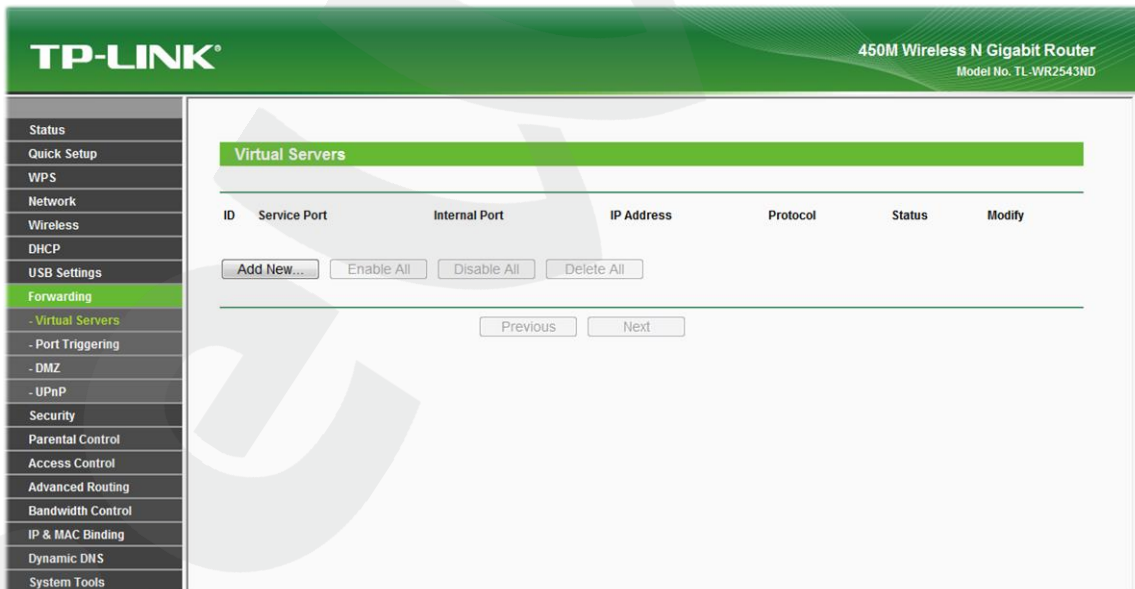

Pic. 6.6

Step 3: create the port forwarding rules (*Pic. 6.7*):

[Service Port]: specify a port number for access to the camera over the Internet.

NOTE:

Do not use the registered port numbers to avoid clashes. It is recommended to use the port numbers within the range of 1124-7999 (the port numbers from 0 to 1123 are officially registered for different protocols, services, applications).

[Internal Port]: enter the port number which is currently used for access to the camera over a local network.

[IP Address]: enter the port number of the IP camera you are setting.

Create the rule for HTTP port (*Pic. 6.7*).

TP-LINK® 450M Wireless N Gigabit Router
Model No. TL-WR2543ND

Add or Modify a Virtual Server Entry

Service Port: 81 (XX-XX or XX)
Internal Port: 80 (XX, Only valid for single Service Port or leave it blank)
IP Address: 192.168.1.199
Protocol: All
Status: Enabled
Common Service Port: --Select One--

Save Back

Pic. 6.7

Step 4: click **[Save]**. The rule is added (*Pic. 6.8*).

TP-LINK® 450M Wireless N Gigabit Router
Model No. TL-WR2543ND

Virtual Servers

ID	Service Port	Internal Port	IP Address	Protocol	Status	Modify
1	81	80	192.168.1.199	All	Enabled	Modify Delete

Add New... Enable All Disable All Delete All

Previous Next

Pic. 6.8

Step 5: create the rule for RTSP port in the same way (*Pic. 6.9*).

IMPORTANT!

It is acceptable to share the same HTTP port between your IP cameras using port forwarding on the virtual server. However, you must specify a unique RTSP port number for each camera in order to access them over the Internet. For example, the port 3001 of the camera 1 should be forwarded to the port 3001 of the router, the port 3002 of the camera 2 - to the port 3002 of the router and so on.

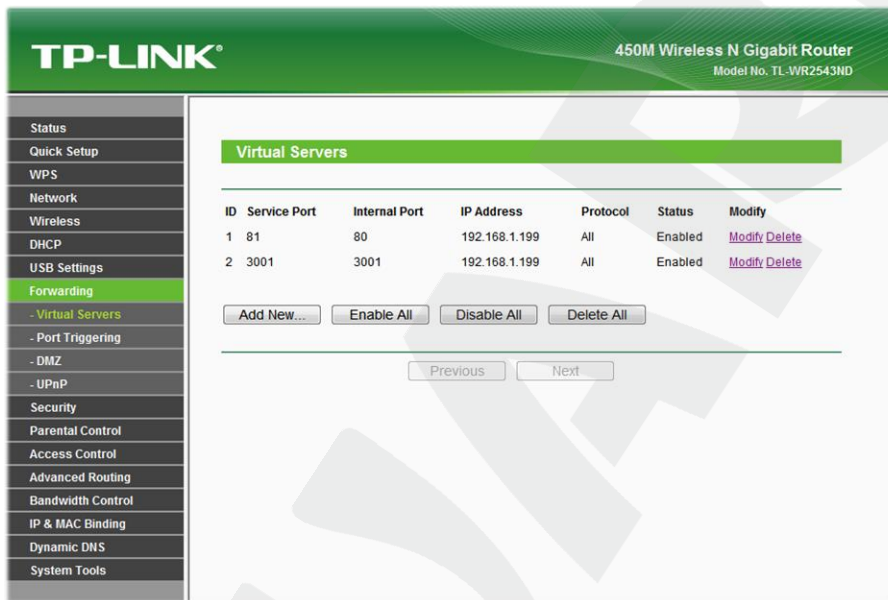

Pic. 6.9

Step 6: if you use several cameras, repeat steps from 2 to 5 for the other ones (Pic. 6.10).

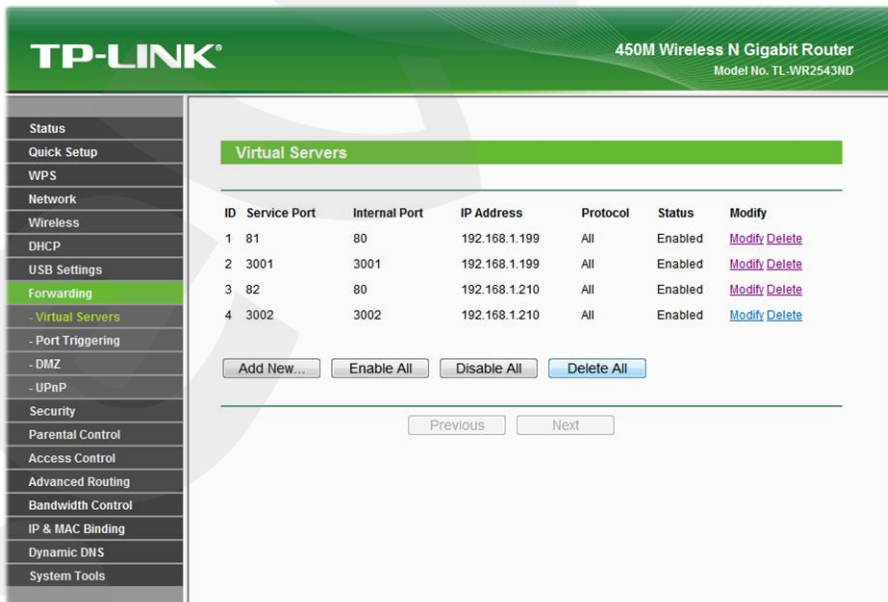

Pic. 6.10

The router configuration is complete.

To access the camera over the Internet, use the IP address provided by your ISP (the “external” IP address of the router) and a certain HTTP port number.

For the provided example, the router’s IP address is 77.108.73.169 and the HTTP port number is 81. Therefore, you need to enter the following in the address field of your browser: **http://77.108.73.169:81/**.

6.4. Accessing over the Internet Using DynDNS Service

6.4.1. Overview of Internet Access to Cameras Using DynDNS service

If a computer is assigned a temporary IP address changing from one session to the next, it means the computer is assigned a dynamic IP address. Many ISPs use this type of addressing. However, in order to access a device over the Internet any time, you need to contact your ISP and ask them to assign a static IP address, or use a Dynamic DNS (DDNS) service.

The Dynamic DNS service allows you to make your cameras accessible over the Internet even though they are assigned a dynamic IP address, which changes from time to time. All external users can always access the camera using its domain name.

The Dynamic DNS service allows you to access your camera over the Internet using its domain name, which might be similar to www.camera1.dvrDNS.org, instead of an IP address.

To do so, create an account at the DDNS server website such as www.dyndns.org, enter your camera's current IP address and choose a domain name that will be used to access your camera.

When either the IP address is changed or a new connection is established, the ISP assigns your camera a new IP address. Then it is processed by the software built into the camera and sent to the DDNS server. The DDNS provider ties the domain name you chose to the dynamic IP address.

For this example, we use the following DDNS provider: www.dyndns.com. To tie a domain name to the IP address of your camera, follow the steps below:

- Create an account at www.dyndns.com – **[Account]**.
- Choose a domain name for your camera – **[Hostname]**. You can use any domain name that is not already being used. For this example, we use camera184 and thus have the following domain name: www.camera184.dvrDNS.org.
- Set up your equipment.

6.4.2. Creating an Account at DynDNS Service

Step 1: open your browser and go to www.dyndns.com, click the **[Sign In]** in the upper right corner and select the **[Create an Account]** in the drop-down menu (*Pic. 6.11*).

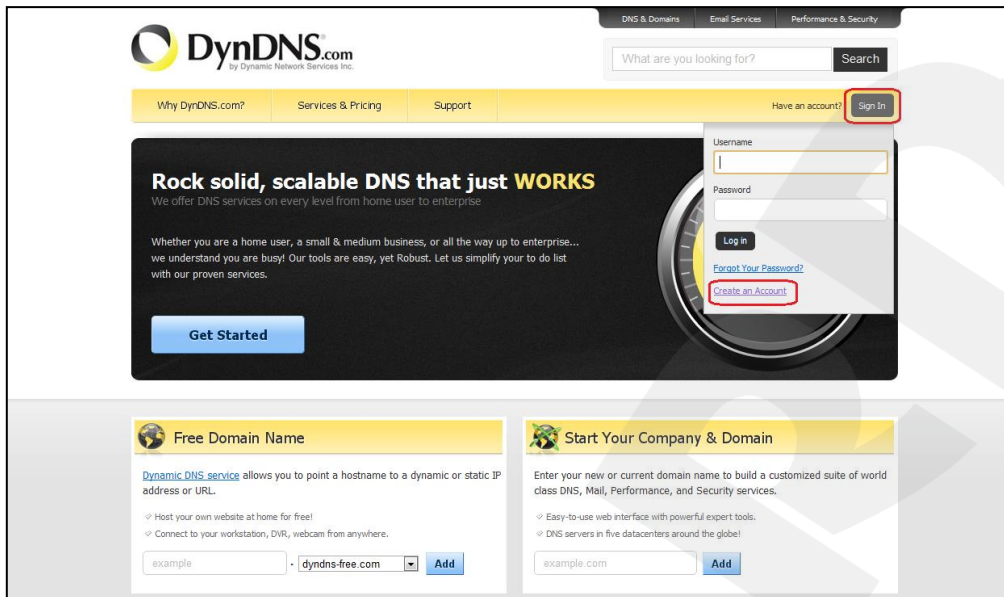

Pic. 6.11

Next you will see the Create an account page (Pic. 6.12).

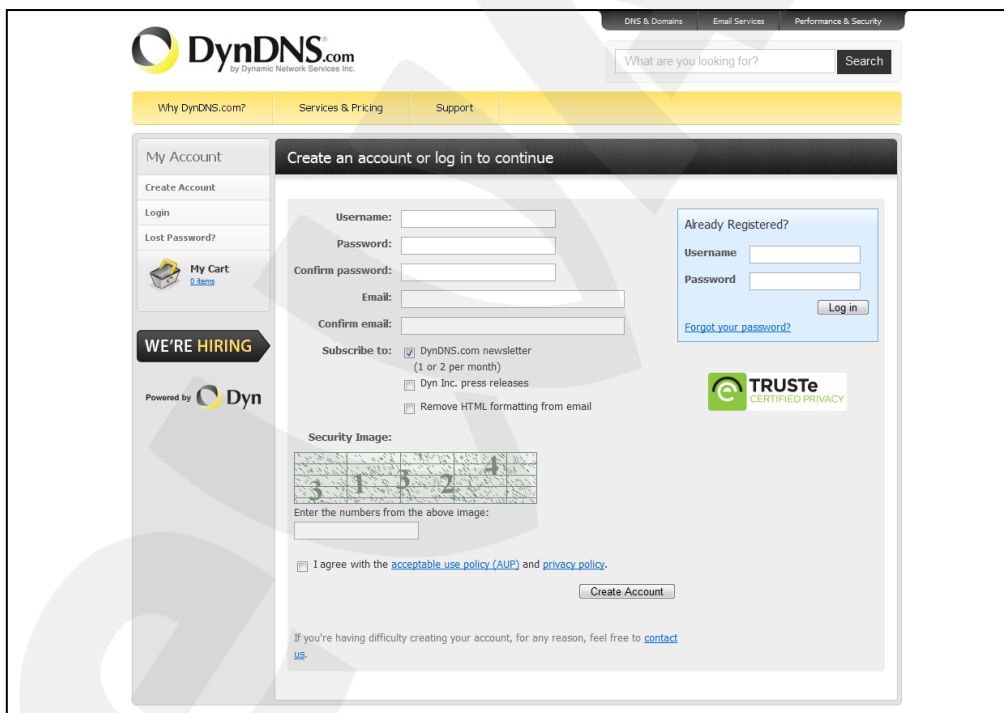

Pic. 6.12

Step 2: enter a username that is not already being used (the **[Username]** field) and a password (the **[Password]** and **[Confirm password]** fields).

NOTE:

You need to confirm the password to ensure that there are no typing mistakes. You must enter the same password in both fields.

In the **[Email]** and **[Confirm email]** fields, enter your e-mail address. You will receive a confirmation e-mail to the specified address. An e-mail address can only be associated with one domain name.

NOTE:

A fee is required to associate one e-mail address with multiple domain names.

NOTE:

You need to confirm the e-mail address to ensure that there are no typing mistakes. You must enter the same e-mail address in both fields.

Check the **[DynDNS.com newsletter]** box to get newsletters from DynDNS or uncheck this box if you wish to cancel newsletters.

Enter the numbers from the image and check the **[I agree with the acceptable use policy (AUP) and privacy policy]** box, which means that you agree with AUP and privacy policy to create one free account.

For this example, we use **[Username]** – camera184, **[Email]** - camera184@yandex.ru.

Click the **[Create Account]** button to complete the registration process (*Pic. 6.13*).

Pic. 6.13

Step 3: if everything is correct, you will see the **[One more step to go...]** page (*Pic. 6.14*).

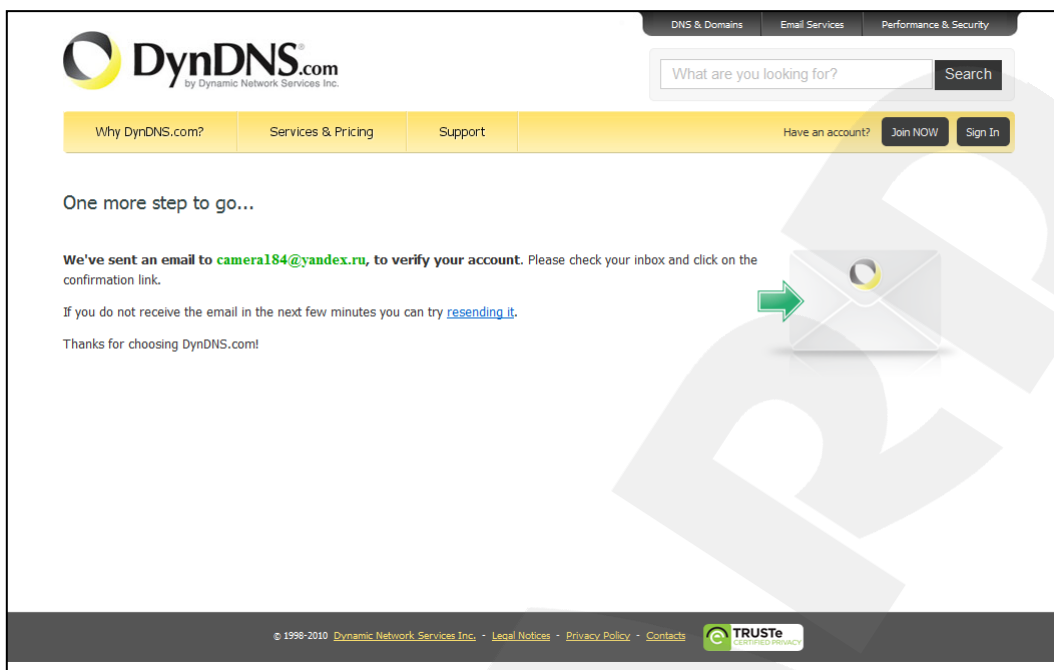

Pic. 6.14

Step 4: you will receive an email confirmation message from «DynDNS Support» (the e-mail address is support@dyndns.com) to the email address you specified in your registration form. Click the link to confirm the registration and to activate your account.

After clicking the link from the e-mail, you will be sent to the confirmation page to activate your account. Enter your username and your password to log in and click the **[Confirm Account]** button (Pic. 6.15).

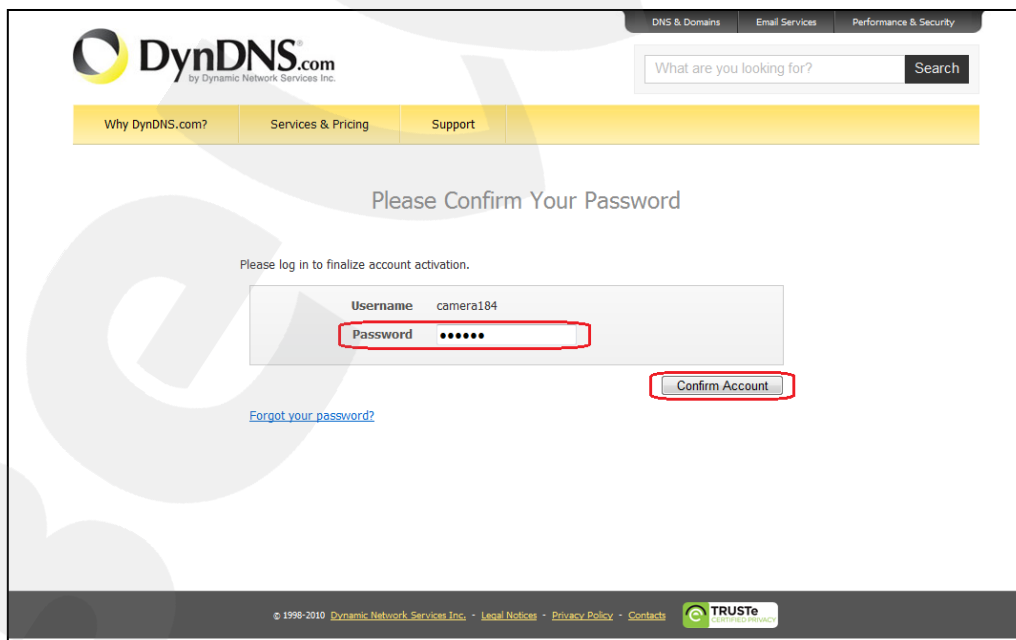

Pic. 6.15

Step 5: your DynDNS account is created (Pic. 6.16).

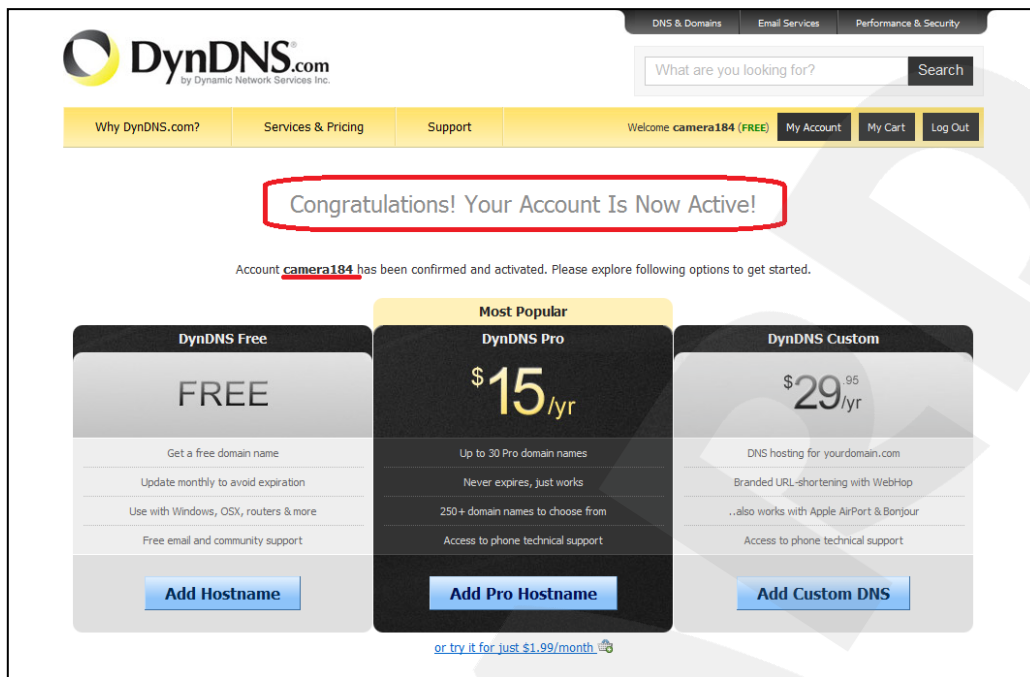

Pic. 6.16

6.4.3. Creating a Domain Name at DynDNS

Step 1: open your browser, go to www.dyndns.com and log in with your username and your password. To do so, click the **[Sign In]** button in the upper right corner and enter your username in the **[Username]** field and your password in the **[Password]** field, then click the **[Log In]** button (Pic. 6.17).

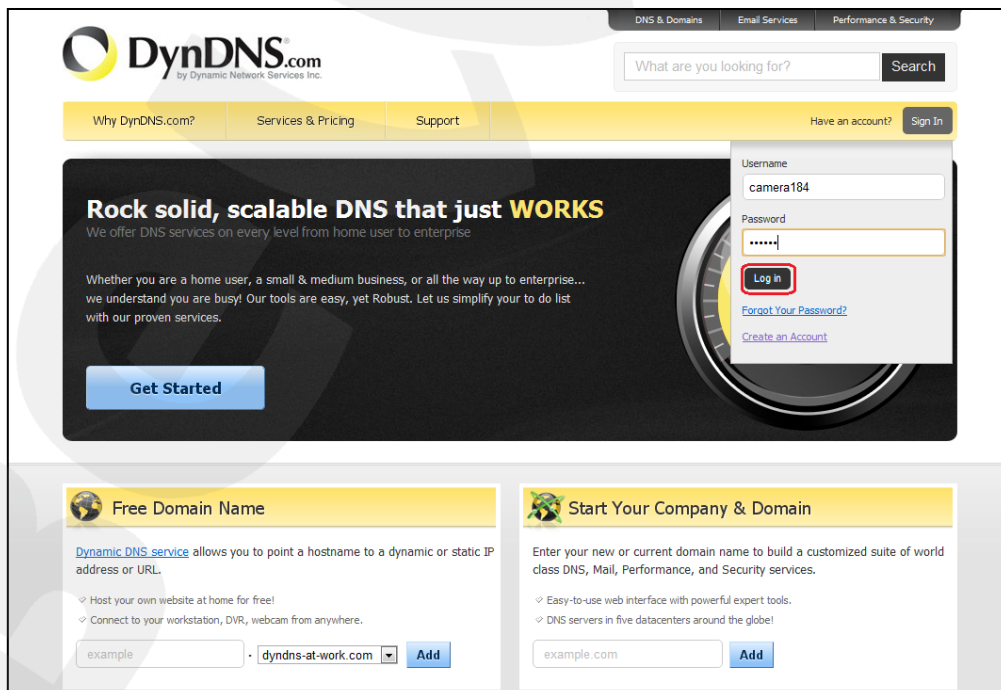

Pic. 6.17

Step 2: if the username and password are correct, you will see your account settings page.

To continue, click the **[Add Host Services]** (Pic. 6.18).

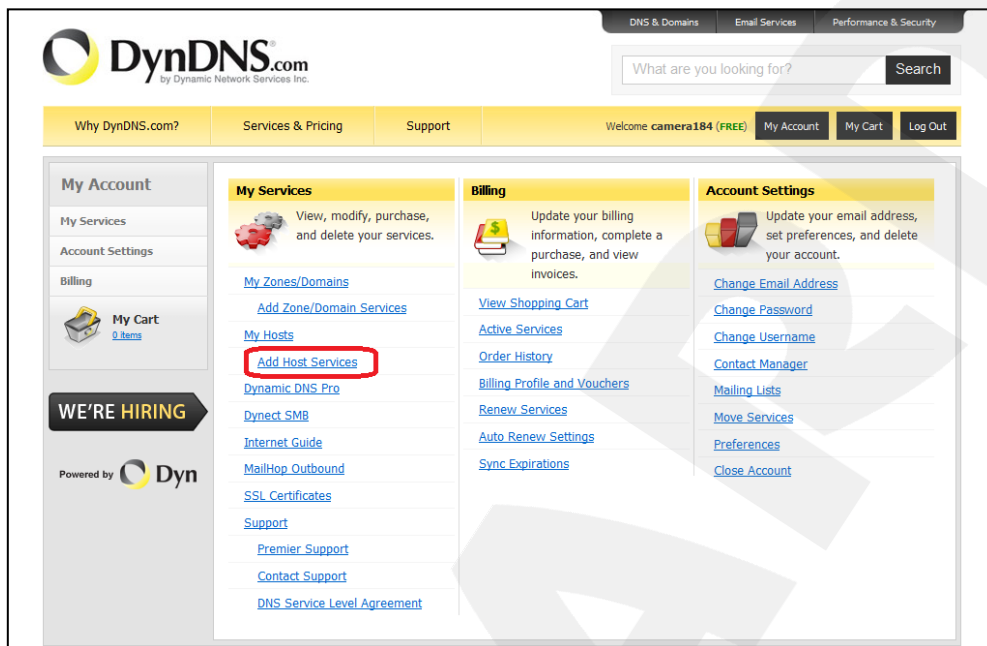

Pic. 6.18

Step 3: in the opened page, configure the connection settings. Select a domain. For this example, we use dyndns.org.

In the **[Hostname]** field, enter a domain name for you camera (e.g. camera184). If the domain name is available, the camera will be accessible at camera184.dyndns.org (Pic.6.19).

The screenshot shows the DynDNS.com 'Add New Hostname' page. The page has a navigation bar with 'DNS & Domains', 'Email Services', and 'Performance & Security'. Below the navigation bar, there are links for 'Why DynDNS.com?', 'Services & Pricing', and 'Support'. The user is logged in as 'camera184 (next)'. The page title is 'Add New Hostname' with a sub-link for '1 Host Services'. The main content area contains a form for adding a new hostname. The form has the following fields and options:

- Hostname:** camera184 . dyndns.org
- Wildcard:** create *.host.dyndns-yourdomain.com alias (for example to use same settings for www.host.dyndns-yourdomain.com)
- Service Type:**
 - Host with IP address
 - WebHop Redirect (URL forwarding service)
 - Offline Hostname
- IP Address:** 89.105.128.207
Your current location's IP address is 89.105.128.207
TTL value is 60 seconds. [Edit TTL...](#)
- Mail Routing:** I have mail server with another name and would like to add MX hostname...
- What do you want to use this host for?** Select services and devices you would like to use with this hostname.
 - Work From Home Office or VPN: vpn, remote file access, remote desktop, mail server, web server, chat server, ftp backup, ssh, database, voip
 - Hosting and Design For Web Sites and Blogs: blog, gallery, wiki, portfolio, ecommerce, web page
 - Remote Access For Devices: dvr, webcam, data storage, cctv, printer, alarm and security, thermostat, weather station, game server, home automation
- Add To Cart.** (highlighted with a red box)

Pic. 6.19

To tie the current IP address of your camera to the specified domain name, please enter its IP address in the **[IP address field]**. By default, DynDNS service determines the IP address from which you are connecting to the service (Pic. 6.20).

The close-up screenshot shows the 'IP Address' field in the DynDNS form. The field is empty, and the text 'Your current location's IP address is 89.105.128.207' is displayed below it. The 'TTL value is 60 seconds. Edit TTL...' text is also visible.

Pic. 6.20

Enter the IP address assigned by your ISP and click the **[Add To Cart]** button.

Step 4: if the domain name is created successfully, you will see the confirmation page. In the provided example, camera184.dyndns.org domain name is created. To activate your domain name, click **[Next]** (Pic. 6.21).

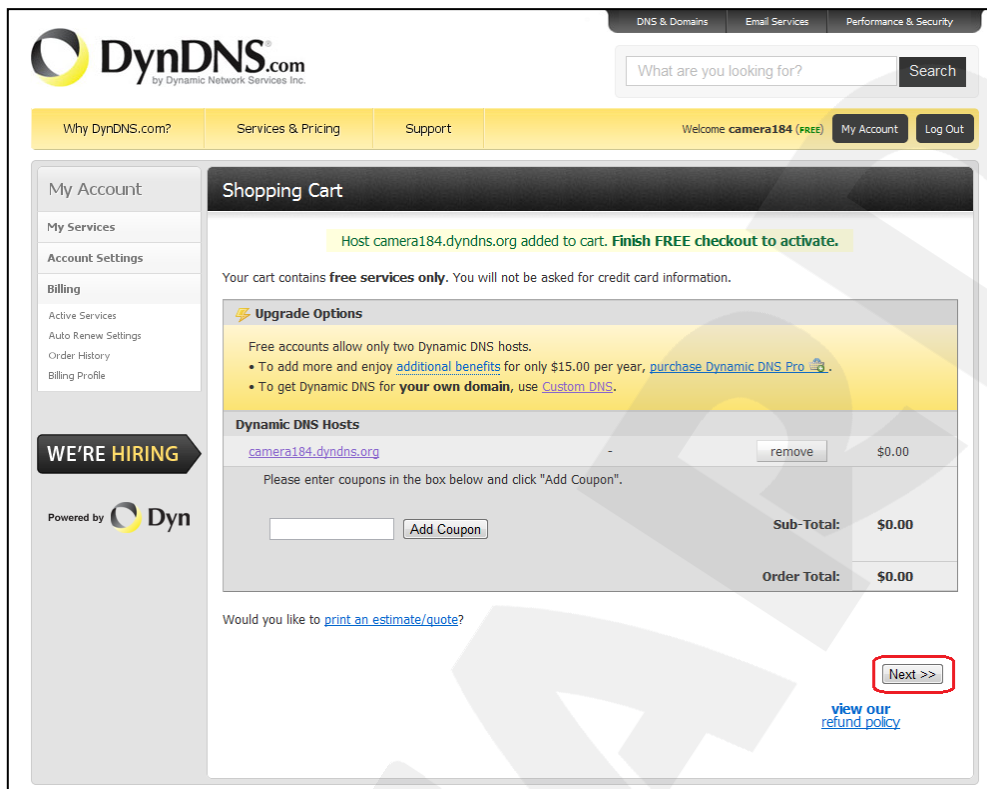

Pic. 6.21

In the opened page, click the **[Activate Service]** button (Pic. 6.22).

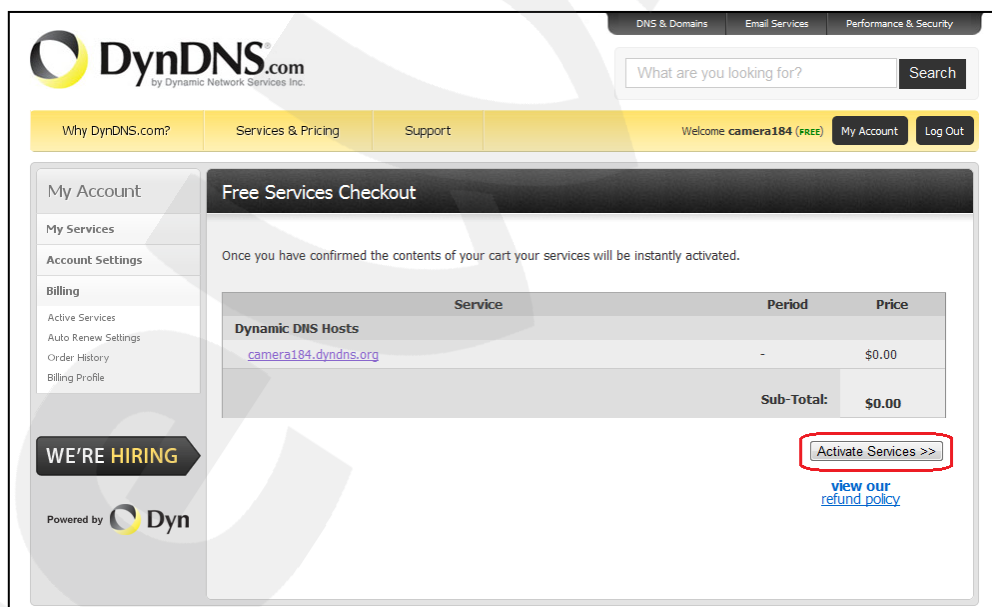

Pic. 6.22

Step 5: if your domain name is activated successfully, you will see the confirmation page (Pic. 6.23).

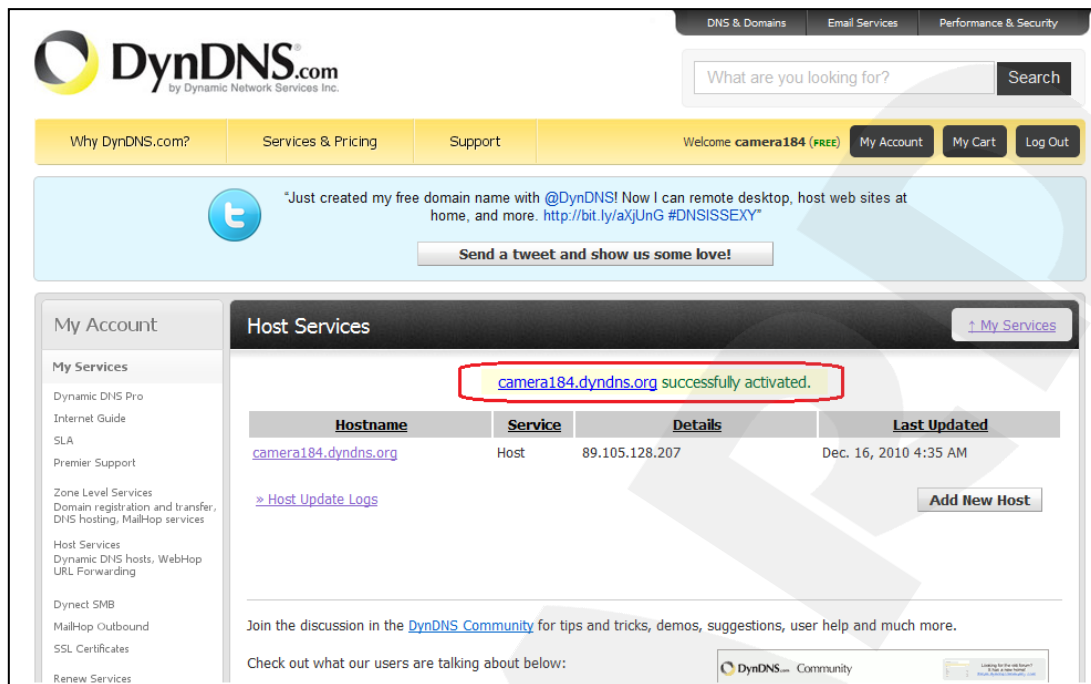

Pic. 6.23

Step 6: your domain name is created.

6.4.4. Setting up the Equipment to Work with DynDNS

After the previous steps are completed, you need to set up your camera according to your registration details at DynDNS service.

The IP camera and a router (in case if you camera is connected to the Internet through a router) can both update the IP address at DynDNS server.

To set up your camera to work with DynDNS service, please follow the steps below:

IMPORTANT!

Your camera must be connected to the Internet directly.

Step 1: enable the [DDNS] option at **SETTING – Network – DDNS**.

Step 2: select a DDNS provider in the [Server name].

Step 3: enter the username that you chose at registration in the [User ID].

Step 4: enter the password that you chose at registration in the [Password].

Step 5: re-type the password in the [Re-type password].

Step 6: enter the domain name that you chose at registration in the [Host name].

IMPORTANT!

For detailed information on how to configure the camera through the web interface, please refer to the Operations User Manual.

According to the registration details that were specified at DynDNS server, select “www.dyndns.org” in the **[Server name]** field. Enter “camera184” in the **[User ID]** and “123456” in the **[Password]**. Enter “camera184.dyndns.org” in the **[Host name]** (*Pic. 6.24*).

Step 7: click **[Save]** to save the changes.

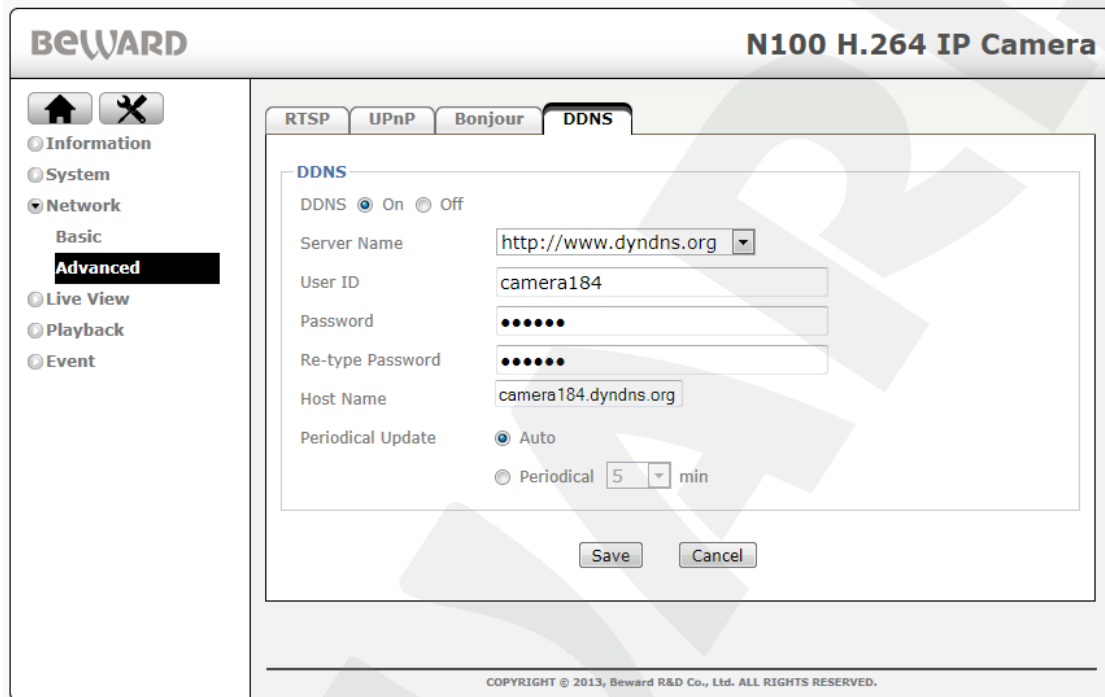

The screenshot shows the BEWARD N100 H.264 IP Camera web interface. The left sidebar contains navigation options: Information, System, Network (selected), Live View, Playback, and Event. Under Network, there are sub-options for Basic and Advanced (highlighted). The main content area has tabs for RTSP, UPnP, Bonjour, and DDNS. The DDNS tab is active, displaying a configuration form. The form includes a DDNS status toggle (On/Off), a Server Name dropdown menu, text input fields for User ID, Password, and Re-type Password, a Host Name text input field, and a Periodical Update section with radio buttons for Auto and Periodical (5 min). Save and Cancel buttons are located at the bottom of the form. A copyright notice is visible at the bottom of the interface.

Pic. 6.24

IMPORTANT!

After you configure the network settings, you must reboot the camera.

IMPORTANT!

If a host is not updated within 35 days, it will be removed from the system.

Step 8: the camera configuration is completed.

Let's consider an example of setting up DDNS on a router by configuring Planet XRT-401D. Routers of other manufacturers are configured identically; please refer to the router's manual for more information on how to configure DDNS. The router is configured to work with DynDNS as follows:

IMPORTANT!

Make sure your router supports DDNS, is connected to the Internet and configured properly.

Step 1: enter the IP address of your router in the browser address field. In the appeared window, enter your username and your password. After successful authorization, the router settings page appears. Click the **[General Setup]** (Pic. 6.25).

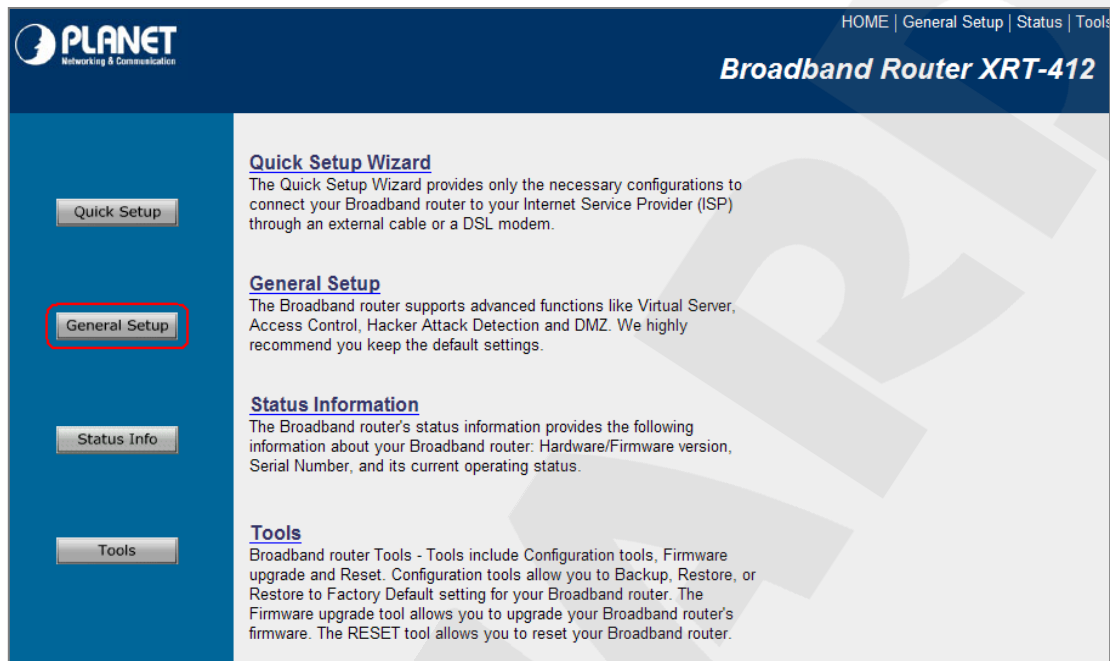

Pic. 6.25

Step 2: click the **[DDNS]** in the opened menu. Click the **[Enable]** to enable the DDNS option.

Step 3: according to the registration details that were specified at DynDNS server, select “www.dyndns.org” in the **[Provider]** field. Enter “camera184.dyndns.org” in the **[Domain Name]**, enter “camera184” in the **[Account / E-Mail]** and “123456” in the **[Password / Key]** field (Pic. 6.26).

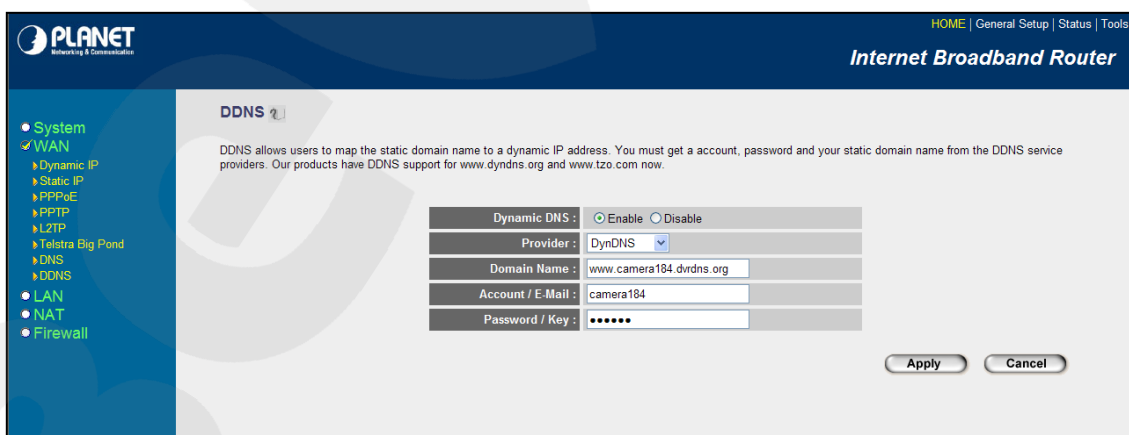

Pic. 6.26

IMPORTANT!

Make sure you have entered the valid data; otherwise, your router will not be able to connect to the DDNS server.

Step 4: click the **[Apply]** to save the changes.

Step 5: the router configuration is completed.

If everything is configured correctly, your camera will be available from anywhere in the world and accessible under the unique name that is easy to remember. From now on, you need to enter <http://camera184.dyndns.org> in your browser address field to access your camera and if everything was done correctly, you should see the camera main window.

Appendix

Appendix A. Port Values

Port	Default Value	Range of Values
HTTP	80	1124..65534
HTTP forwarding via UPnP	80	1024..65534
HTTPS forwarding via UPnP	443	1024..65534
RTSP	554	1124..65534
RTSP forwarding via UPnP	554	1024..65534
Initial RTP range port	5000	1124..65435
Final RTP range port	7999	1223..65534
Multicast video port	-	1124..65534
Multicast audio port	-	1124..65534
SMTP	25	1..65535
System log remote server port	514	1024..65534
Event server port	80	1..65535
Proxy server port	-	1..65535
Motion detection	1999	-
MPEG4 streaming (HTTP)	80	1124..65534
MJPEG streaming (HTTP)	80	1124..65534

Appendix B. Factory Defaults

This table provides camera factory defaults

Parameter	Value
IP address	192.168.0.99
Subnet mask	255.255.255.0
Gateway	192.168.0.1
Username (administrator)	admin
Password (administrator)	admin
HTTP port	80
RTSP port	554
SMTP port	25

Appendix C. Glossary

3GP (3GPP file format) is a multimedia container format defined by the Third Generation Partnership Project (3GPP) for 3G UMTS multimedia services. It is used on 3G mobile phones but can also be played on some 2G and 4G phones.

ActiveX is a standard that enables software components to interact with one another in a networked environment, regardless of the language(s) used to create them. Web browsers may come into contact with ActiveX controls, ActiveX documents, and ActiveX scripts. ActiveX controls are often downloaded and installed automatically as required.

Asymmetric Digital Subscriber Line (ADSL) is an obsolete type of Digital Subscriber Line technology, a data communications technology that enables faster data transmission over copper telephone lines than a conventional voiceband modem can provide.

Angle is the field of view, relative to a standard lens in a 35mm still camera, expressed in degrees, e.g. 30°. For practical purposes, this is the area that a lens can cover, where the angle of view is determined by the focal length of the lens. A wide-angle lens has a short focal length and covers a wider angle of view than standard or telephoto lenses, which have longer focal lengths.

ARP (Address Resolution Protocol) is used to associate an IP address to a hardware MAC address. A request is broadcast on the local network to discover the MAC address for an IP address.

Aspect ratio is a ratio of width to height in images. A common aspect ratio used for television screens and computer monitors is 4:3. High-definition television (HDTV) uses an aspect ratio of 16:9.

Authentication is the process of identifying an individual, usually based on a username and password. In security systems, authentication is distinct from authorization, which is the process of giving individuals access to system objects based on their identity. Authentication merely ensures that the individual is who he or she claims to be, but says nothing about the access rights of the individual.

Autoiris (or DC-Iris). This special type of iris is electrically controlled by the camera, to automatically regulate the amount of light allowed to enter.

Bit rate: (in kbit/s or Mbit/s) is often referred to as speed, but actually defines the number of bits/time unit and not distance/time unit.

Backlight Compensation compensates for strong backlighting, so that subjects appear clearly instead of as silhouettes.

Bonjour, also known as zero-configuration networking, Bonjour enables automatic discovery of computers, devices, and services on IP networks. Bonjour allows devices to automatically discover each other without the need to enter IP addresses or configure DNS servers. Bonjour is developed by Apple Computer Inc.

CCD (Charged Coupled Device). This light-sensitive image device used in many digital cameras is a large integrated circuit that contains hundreds of thousands of photo-sites (pixels) that convert light energy into electronic signals. Its size is measured diagonally and can be 1/4", 1/3", 1/2" or 2/3".

CGI (Common Gateway Interface) is a specification for communication between a web server and other (CGI) programs. For example, a HTML page that contains a form might use a CGI program to process the form data once it is submitted.

Classless Inter Domain Routing (CIDR) is a method for assigning IP addresses without using the standard IP address classes like Class A, Class B or Class C. In CIDR notation, an IP address is represented as A.B.C.D /n, where "/n" is called the IP prefix or network prefix. The IP prefix identifies the number of significant bits used to identify a network. For example, 192.9.205.22 /18 means, the first 18 bits are used to represent the network and the remaining 14 bits are used to identify hosts. Common prefixes are 8, 16, 24, and 32.

Complementary metal–oxide–semiconductor (CMOS) is a technology for constructing integrated circuits. CMOS technology is used in microprocessors, microcontrollers, static RAM, and other digital logic circuits. CMOS technology is also used for several analog circuits such as image sensors (CMOS sensor), data converters, and highly integrated transceivers for many types of communication.

Dynamic DNS is a method/protocol/network service that provides the capability for a networked device, such as a router or computer system using the Internet Protocol Suite, to notify a Domain Name System (DNS) name server to change, in real time, the active DNS configuration of its configured hostnames, addresses or other information.

DHCP (Dynamic Host Configuration Protocol) is a protocol that lets network administrators automate and centrally manage the assignment of Internet Protocol (IP) addresses to network devices in a network. DHCP uses the concept of a "lease" or amount of time that a given IP address will be valid for a computer. The lease time can vary, depending on how long a user is likely to require the network connection at a particular location. DHCP also supports static addresses for e.g. computers running web servers, which need a permanent IP address.

Digital zoom is a method of decreasing (narrowing) the apparent angle of view of a digital photographic or video image. Digital zoom is accomplished by cropping an image down to a centered area with the same aspect ratio as the original, and usually also interpolating the result back up to the pixel dimensions of the original. It is accomplished electronically, with no adjustment of the camera's optics, and no optical resolution is gained in the process.

Domain server can also be used by organizations that wish to centralize the management of their (Windows) computers. Each user within a domain has an account that usually allows them to log in to and use any computer in the domain, although restrictions may also apply. The domain server is the server that authenticates the users on the network.

Ethernet is the most widely installed local area network technology. An Ethernet LAN typically uses special grades of twisted pair wires. The most commonly installed Ethernet systems are 10BASE-T and 100BASE-T10, which provide transmission speeds up to 10 Mbps and 100 Mbps respectively.

Factory default settings are the settings that originally applied for a device when it was first delivered from the factory. If it should become necessary to reset a device to its factory default settings, this will, for many devices, completely reset any settings that were changed by the user.

Firewall works as a barrier between networks, e.g. between a Local Area Network and the Internet. The firewall ensures that only authorized users are allowed to access the one network from the other. A firewall can be software running on a computer, or it can be a standalone hardware device.

Focal length is measured in millimeters; the focal length of a camera lens determines the width of the horizontal field of view, which in turn is measured in degrees.

FPS (frames per second) a measure of how much information is used to store and display motion video. The term applies equally to film video and digital video. Each frame is a still image; displaying frames in quick succession creates the illusion of motion. The more frames per second (fps), the smoother the motion appears.

Frame is a complete video image. In the 2:1 interlaced scanning format of the RS-170 and CCIR formats, a frame is made up of two separate fields of 262.5 or 312.5 lines interlaced at 60 or 50 Hz to form a complete frame, which appears at 30 or 25 Hz. In video cameras with a progressive scan, each frame is scanned line-by-line and not interlaced; most are also displayed at 30 and 25 Hz.

FTP (File Transfer Protocol) is an application protocol that uses the TCP/IP protocols, used to exchange files between computers/devices on networks.

Full-duplex means transmission of data in two directions simultaneously. In an audio system this would describe e.g. a telephone system. Half-duplex also provides bi-directional communication, but only in one direction at a time, as in a walkie-talkie system.

G.711 is the default pulse code modulation (PCM) standard for Internet Protocol (IP) private branch exchange (PBX) vendors, as well as for the public switched telephone network (PSTN). G.711 digitizes analog voice signals producing output at 64 kilobits per second (Kbps).

Gain is the amplification factor and the extent to which an analog amplifier boosts the strength of a signal. Amplification factors are usually expressed in terms of power. The decibel (dB) is the most common way of quantifying the gain of an amplifier.

Gateway is a point in a network that acts as an entry point to another network. In a corporate network for example, a computer server acting as a gateway often also acts as a proxy server and a firewall server. A gateway is often associated with both a router, which knows where

to direct a given packet of data that arrives at the gateway, and a switch, which furnishes the actual path in and out of the gateway for a given packet.

HTTP (Hypertext Transfer Protocol) is the set of rules for exchanging files (text, graphic images, sound, video, and other multimedia files) on the web. The HTTP protocol runs on top of the TCP/IP suite of protocols.

HTTPS (Hypertext Transfer Protocol over SSL) is a web protocol used by browsers and web servers to encrypt and decrypt user page requests and the pages returned by the server. The encrypted exchange of information is governed by the use of an HTTPS certificate (issued by a Certificate Authority), which guarantees the authenticity of the server.

Hub is used to connect multiple devices to the network. The hub transmits all data to all devices connected to it, whereas a switch will only transmit the data to the device it is specifically intended for.

ICMP is a network protocol useful in Internet Protocol (IP) network management and administration. ICMP is a required element of IP implementations. ICMP is a control protocol, meaning that it does not carry application data, but rather information about the status of the network itself.

IEEE 802.11 is a family of standards for wireless LANs. The 802.11 standard supports 1 or 2 Mbit/s transmission on the 2.4 GHz band. IEEE 802.11b supports data rates up to 11 Mbit/s on the 2.4 GHz band, while 802.11g allows up to 54 Mbit/s on the 5 GHz band.

Interlacing. Interlaced video is video captured at 50 pictures (known as fields) per second, of which every 2 consecutive fields (at half height) are then combined into 1 frame. Interlacing was developed many years ago for the analog TV world and is still used widely today. It provides good results when viewing motion in standard TV pictures, although there is always some degree of distortion in the image.

Internet Explorer (formerly Microsoft Internet Explorer, commonly abbreviated IE or MSIE) is a series of graphical web browsers developed by Microsoft and included as part of the Microsoft Windows line of operating systems, starting in 1995.

IP66 is a two digit number developed by the international electrical Commission, and is used to provide Ingress Protection (IP) rating to a piece of electronic equipment or to an enclosure for electronic equipment. The Ingress protection code indicates the level and amount of protection. The first digit means no ingress of dust; complete protection against contact. The second digit means water projected in powerful jets (12.5mm nozzle) against the enclosure from any direction shall have no harmful effects.

IP camera. The terms IP camera, network camera and Internet camera all refer to the same thing - a camera and computer combined in one unit. It operates as stand-alone unit and only requires a connection to the network.

JPEG (Joint Photographic Experts Group). Together with the GIF file format, JPEG is an image file type commonly used on the web. A JPEG image is a bitmap, and usually has the file extension '.jpg' or ".jpeg." When creating a JPEG image, it is possible to configure the level of compression to use. As the lowest compression (i.e. the highest quality) results in the largest file, there is a trade-off between image quality and file size.

kbit/s (kilobits per second) is a measure of the bit rate, i.e. the rate at which bits are passing a given point. See also Bit rate.

LAN (Local Area Network) is a group of computers and associated devices that typically share common resources within a limited geographical area.

Lux is a standard unit of illumination measurement.

MAC address (Media Access Control address) is a unique identifier associated with a piece of networking equipment, or more specifically, its interface with the network. For example, the network card in a computer has its own MAC address.

Mbit/s (Megabits per second) is a measure of the bit rate, i.e. the rate at which bits are passing a given point. Commonly used to give the "speed" of a network. A LAN might run at 10 or 100 Mbit/s.

Motion JPEG is a simple compression/decompression technique for network video. Latency is low and image quality is guaranteed, regardless of movement or complexity of the image. Image quality is controlled by adjusting the compression level, which in turn provides control over the file size, and thereby the bit rate.

MPEG-4 is a group of audio and video coding standards and related technology. The primary uses for the MPEG-4 standard are web (streaming media) and CD distribution, conversational (videophone), and broadcast television. Most of the features included in MPEG-4 are left to individual developers to decide whether to implement them or not. This means that there are probably no complete implementations of the entire MPEG-4 set of standards. To deal with this, the standard includes the concept of "profiles" and "levels", allowing a specific set of capabilities to be defined in a manner appropriate for a subset of applications.

Multicast is a bandwidth-conserving technology that reduces bandwidth usage by simultaneously delivering a single stream of information to multiple network recipients.

Network Time Protocol (NTP) is a protocol for synchronizing the clocks of computer systems over packet-switched, variable-latency data networks. It is designed particularly to resist the effects of variable latency by using a jitter buffer.

NTSC (National Television System Committee) is an analog color encoding system used in television systems in Japan, the United States and other parts of the Americas. NTSC defines the video signal using 525 TV lines per frame, at a refresh rate equal to 30 frames per second. See also PAL.

ONVIF (Open Network Video Interface Forum) is a global and open industry forum with the goal to facilitate the development and use of a global open standard for the interface of physical IP-based security products. Or in other words, to create a standard for how IP products within video surveillance and other physical security areas can communicate with each other. ONVIF is an organization started in 2008 by Axis Communications, Bosch Security Systems and Sony.

PAL (Phase Alternating Line) is an analog color encoding system used in television systems in Europe and in many other parts of the world. PAL defines the video signal using 625 TV lines per frame, at a refresh rate equal to 25 frames per second.

Power over Ethernet or PoE provides power to a network device via the same cable as used for the network connection. This is very useful for IP-Surveillance and remote monitoring applications in places where it may be too impractical or expensive to power the device from a power outlet.

PPP (Point-to-Point Protocol) is a protocol that uses a serial interface for communication between two network devices. For example, a PC connected by a phone line to a server.

Point-to-Point Protocol over Ethernet (PPPoE) is a network protocol for encapsulating Point-to-Point Protocol (PPP) frames inside Ethernet frames. It is used mainly with DSL services where individual users connect to the DSL modem over Ethernet and in plain Metro Ethernet networks.

Progressive scan, as opposed to interlaced video, scans the entire picture, line by line every sixteenth of a second. In other words, captured images are not split into separate fields as in interlaced scanning.

Jack-45 is an eight-wire connector used to connect computers onto a local-area networks (LAN), especially Ethernets. RJ-45 connectors look similar to the RJ-11 connectors used for connecting telephone equipment, but they are a bit wider.

Router is a device that determines the next network point to which a packet should be forwarded on its way to its final destination. A router creates and/or maintains a special routing table that stores information on how best to reach certain destinations. A router is sometimes included as part of a network switch.

RTP is an Internet protocol for the transport of real-time data, e.g. audio and video. It can be used for media-on-demand as well as interactive services such as Internet telephony.

RTSP (Real Time Streaming Protocol) is a control protocol, and a starting point for negotiating transports such as RTP, multicast and Unicast, and for negotiating codecs.

RTSP can be considered a “remote control” for controlling the media stream delivered by a media server. RTSP servers typically use RTP as the protocol for the actual transport of audio/video data.

Shutter is the device on the camera that opens and closes to control how long the focal plane is exposed to light.

SMTP is used for sending and receiving e-mail. However, as it is “simple,” it is limited in its ability to queue messages at the receiving end, and is usually used with one of two other protocols, POP3 or IMAP. These other protocols allow the user to save messages in a server mailbox and download them periodically from the server.

SMTP authentication is an extension of SMTP, whereby the client is required to log into the mail server before or during the sending of email. It can be used to allow legitimate users to send email while denying the service to unauthorized users, such as spammers.

SSL/TLS (Secure Socket Layer/Transport Layer Security). These two protocols (SSL is succeeded by TLS) are cryptographic protocols that provide secure communication on a network. SSL is commonly used over HTTP to form HTTPS, as used e.g. on the Internet for electronic financial transactions. SSL uses public key certificates to verify the identity of the server.

Subnet & subnet mask is an identifiably separate part of an organization's network. Typically, a subnet may represent all the machines at one geographic location, in one building, or on the same local area network (LAN). Having an organization's network divided into subnets allows it to be connected to the Internet with a single shared network address. The subnet mask is the part of the IP address that tells a network router how to find the subnet that the data packet should be delivered to. Using a subnet mask saves the router having to handle the entire 32-bit IP address; it simply looks at the bits selected by the mask.

Switch is a network device that connects network segments together, and which selects a path for sending a unit of data to its next destination. In general, a switch is a simpler and faster mechanism than a router, which requires knowledge about the network and how to determine the route. Some switches include the router function.

TCP is used along with the Internet Protocol (IP) to transmit data as packets between computers over the network. While IP takes care of the actual packet delivery, TCP keeps track of the individual packets that the communication (e.g. requested a web page file) is divided into, and, when all packets have arrived at their destination, it reassembles them to re-form the complete file.

TCP is a connection-oriented protocol, which means that a connection is established between the two end-points and is maintained until the data has been successfully exchanged between the communicating applications.

Time to live (TTL) is mechanism that limits the lifespan of data in a computer or network. TTL may be implemented as a counter or timestamp attached to or embedded in the data. Once the prescribed event count or timespan has elapsed, data is discarded. In computer networking, TTL prevents a data packet from circulating indefinitely. In computing applications, TTL is used to improve performance of caching or improve privacy.

UDP is a communications protocol that offers limited service for exchanging data in a network that uses the Internet Protocol (IP). UDP is an alternative to the Transmission Control Protocol (TCP). The advantage of UDP is that it is not required to deliver all data and may drop network packets when there is e.g. network congestion. This is suitable for live video, as there is no point in re-transmitting old information that will not be displayed anyway.

Universal Plug and Play (UPnP) is a set of networking protocols for primarily residential networks without enterprise class devices that permits networked devices, such as personal computers, printers, Internet gateways, Wi-Fi access points and mobile devices to seamlessly discover each other's presence on the network and establish functional network services for data sharing, communications, and entertainment.

Uniform Resource Locator or Unified Resource Locator (URL) is a character string that specifies where a known resource is available on the Internet and the mechanism for retrieving it.

Wireless Application Protocol (WAP) is a technical standard for accessing information over a mobile wireless network. A WAP browser is a web browser for mobile devices such as mobile phones (called "cellular phones" in some countries) that uses the protocol.

Web server is a program, which allows Web browsers to retrieve files from computers connected to the Internet. The Web server listens for requests from Web browsers and upon receiving a request for a file sends it back to the browser.

The primary function of a Web server is to serve pages to other remote computers; consequently, it needs to be installed on a computer that is permanently connected to the Internet. It also controls access to the server whilst monitoring and logging server access statistics.

Wireless LAN is a wireless local area network that uses radio waves as its carrier: where the network connections for end-users are wireless. The main network structure usually uses cables.